

Albion Engineering Company Handbook & Catalog

Providing You with
Tools & Technical Information to Solve
Your Application Needs

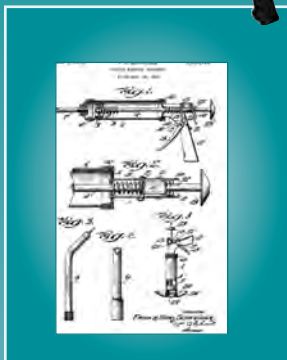

How Fast is Fast! this Cordless Gun can dramatically decrease the amount of time on a work site. For example filling a 1/4 inch x 1/8 inch joint the length of a football field can be done in less than 2 minutes. That's equivalent to 202 feet per minute.

.....

$$F \text{ (force)} = P \text{ (pressure)} \times A \text{ (area)}$$

(force):
generated by Drive

(pressure): in
Material Containment Unit

(area):
surface area of piston



Over
80 Years
of Dispensing
Solutions

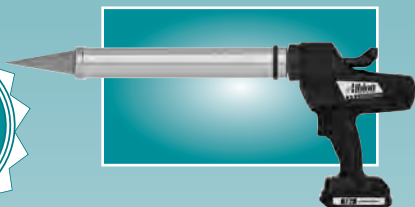

 **Albion**[®]
DISPENSING SOLUTIONS

www.albioneng.com

Catalog 333

3RD Edition

Engineering Dispensing Solutions.

Founded in 1929, Albion is a third generation

American manufacturer recognized as a

leader in the field

of dispensing

technologies.

Albion supports

multiple industries

with innovative, high

quality dispensing tools

and accessories for

the most demanding

applications. Please visit our web site and/or

request a catalog.

Pictured above, the original Albion dispenser (patent No. 1986166) dated 1935 from the United States Patent Office.

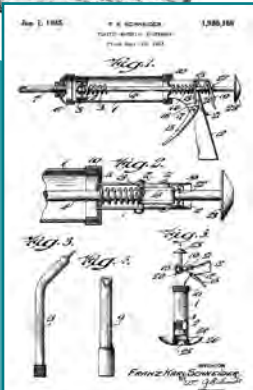
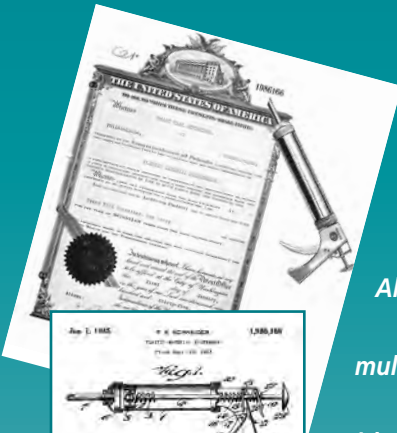

ALBION Engineering Company

1250 N. Church Street Moorestown, NJ 08057-1102
856-235-6688 Fax Toll-Free: 800-841-7132

www.albioneng.com

CONTENTS

How a Dispensing Tool Works	5
Nozzles	6
Material Containment Units (MCU)	7
Drives	8
<u>Bulk Guns</u> : Manual, Air, and Cordless Drives	16
<u>Sausage Guns</u> : Manual, Air, and Cordless Drives	32
<u>Cartridge Guns</u> :	38
Multi-Component Technical Reference Information	45
<u>Multi-Component Guns</u> :	46
Accessories	68
Standard Caps and Nozzles	68
Plastic Nozzles	69
Special Applications: Caps and Nozzles	70
Cartridges and Nozzles	76
Gun Modifiers	78
Bulk Loading Accessories	81
Cleaning Tools	83
Joint Tools	84
Heat Chest (Hot Pot™)	86
Cordless Gun Maintenance	88

BULK

SAUSAGE

CARTRIDGE

MULTI-COMPONENT

ACCESSORIES

INTRODUCTION

I am proud to present to you our catalog and hope you will find it useful and educational. The catalog is divided into 3 major sections.

Background Information— detailing how a tool can be built, the benefits in each segment of the tool and how to select the right tool for your application.

Core Product Selection— sorted by how the material is packaged - bulk, sausage, or cartridge - we provide you with the “Core” tools for each section first and then variations of the core tools, allowing you to select the right tool for your specific needs and application.

Nozzles and Accessories— key components in the application process.

Incorporated within the catalog are “Albion Engineering Tidbits” which are designed to help you understand key elements behind the tools you are selecting and how they are used to improve your application needs.

Albion Engineering Company has served your dispensing needs for over 80 years. I am proud to be the third generation of Schneiders, and I hope our products meet your expectations.

Thank you.

Mark C. Schneider



Mark C. Schneider
President



Franz K. Schneider
1963 - 1999



F. Karl Schneider
1929 - 1963

HOW A DISPENSING TOOL WORKS

How a Dispensing Tool Works— Building a Tool

There are 3 core components in a dispensing tool: **Nozzle**, **Material Containment Unit**, and **Drive**. By customizing these components to meet your specific application needs, you can create the best dispensing tool.

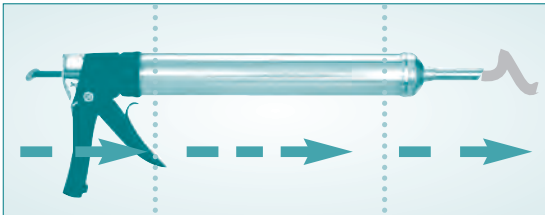

Drive:
Creates initial
force or thrust

Material Containment:
Holds the bulk, sausage or
cartridge material

Nozzle:
Reduces material
to desired width

Drive— mechanism that creates force or thrust. There are three primary types available:

- **Manual Drive:** hand operated, portable, and efficient. Drives are available in a range of ratios depending on the viscosity of the material to be dispensed
- **Air-Powered Drive:** requires an air compressor, regulator, and hose. This setup is best for industrial applications
- **Cordless Drive:** portable, powerful, quick, and effortless

Material Containment Unit (MCU)— contains the material to be dispensed.

- **Bulk Material:** generally in pails
- **Sausage Material:** packaged in a Mylar sleeve which fits a standard tool
- **Cartridge Material:** portable, convenient

Nozzle— determines the size and shape of the material to be dispensed

Albion ENGINEERING Tidbit™

FORCE (thrust) from Drive → PRESSURE in Barrel → FLOW

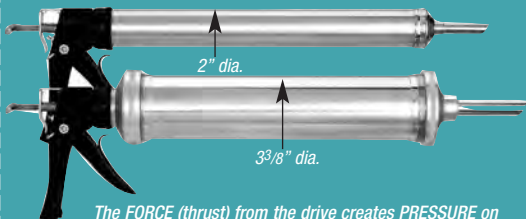

The FORCE (thrust) from the drive creates PRESSURE on the material in the barrel; the piston inside the barrel moves the material. So, as the barrel diameter and piston increase in size, the internal pressure on the material naturally decreases (a drop in PSI).

NOZZLES

Nozzles:

Nozzles determine the size and shape of the material dispensed. The difficulty of pushing material through the nozzle will depend on its length and diameter.

Albion ENGINEERING Tidbit™

Nozzle Diameter Affects Pressure:

As the diameter of the nozzle decreases and its length increases, more pressure is required inside of the material containment unit to dispense the material.

If your application requires a long or thin nozzle, choose a higher thrust drive.



Albion ENGINEERING Tidbit™

Teflon® Facts and Trivia:¹

* PTFE is inert to virtually all chemicals and considered the most slippery material in existence. As a DuPont registered trademark, **Teflon®** has become a familiar household name, recognized worldwide for the superior non-stick properties associated with its use as a coating on cookware and as a soil and stain repellent for fabric and textile products.

* **Teflon®** has been involved in the U.S. space program since the program's infancy. When Neil Armstrong took his historic "giant leap for mankind" in 1969, the moon module included numerous applications involving **Teflon®** resin, including space suits, blankets, heat shields, insulation, and cargo hold liners.

* As a liquid, **Teflon®** repels water and stains for apparel, home fashions, furniture, and uniform markets. **Teflon®** forms a molecular shield around each fiber, guarding them from oil and water-based stains, dust, and soil. ...without affecting their color, feel, or breathability.

* **Teflon®** is in the Statue of Liberty in New York harbor as an insulator and lubricator between the copper skin and the stainless steel skeleton.

* **Teflon®** in a composite sheet form with graphite is used for bearing pads in the George Washington Bridge in New York State to prevent corrosion of the steel plates.

* **Teflon®** is the slipperiest solid substance on Earth with the low static coefficient of friction of 0.04 (**Teflon®** on **Teflon®**).

* Albion is the only Caulking gun company to use **Teflon®** as a barrel coating material inside and out to make dispensing and cleanup easier.

¹The History of **Teflon®** by DuPont.

The Dupont website: [http://www.DuPont tetrafluoroethylene \(PTFE](http://www.DuPont tetrafluoroethylene (PTFE)

BARRELS

Material Containment Units:

Material Containment Units contain the material to be dispensed. The force generated by the Drive System creates pressure inside the Material Containment Unit, forcing the material through the nozzle.

The following are the most common containers for materials:

Throughout the catalog you will see the force generated by the drive system in maximum pounds force (lb_f) and the resulting maximum pressure generated inside the material containment unit in maximum pounds per square inch (psi) pressure associated with each tool.

- **Bulk**— the most cost effective material packaging, generally in 2 or 5 gallon pails that require self loading dispensing tools. Bulk dispensing guns are available in 3 different barrel diameters and in various lengths. Bulk tools come with dual leather pistons that push a multitude of material types.



- **Sausage**— more cost-effective than cartridges. Less waste than cartridges. Sausage and Bulk dispensing tools are quite similar, except in the Sausage dispensing tool the plastic piston replaces the leather pistons to maximize efficiency. Albion highly recommends a solid **Teflon**[®] piston to minimize friction between the piston and the barrel, as well as maintaining the required thrust to dispense materials.

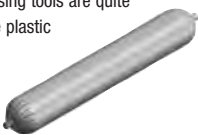

- **Cartridge**— cleanest and easiest packaging to dispense material, but the highest in cost per ounce. Single and two component cartridge designs vary significantly in quality and acceptable maximum pressure.



Bulk and Sausage Dispensing Tool Barrels:

Steel— the standard for many years; durable, reliable, and can be cleaned using a barrel brush (800-G01)

Aluminum— light weight; not as durable as a steel barrel, so care is required with this tool.

Teflon[®]-Coated Steel— a standard steel barrel coated with DuPont's **Teflon[®]**, the slipperiest substance known to man.¹ Its non-stick surface improves clean-up. **Teflon[®]** eases the dispensing tool process and substantially reduces the friction between the piston and barrel when coupled with **Teflon[®]** pistons, thus requiring less thrust to dispense material.

¹ **Teflon[®]** is a registered trademark of DuPont[™] used under license by Albion Engineering Company.

DRIVES

Drive Systems:

Albion Professional Line of Tools: Founded in 1929, Albion is well known in the field for its Professional Line of Dispensing tools. With its USA manufacturing capabilities the Professional Line has reached standards difficult to match anywhere. The lines in this category include the Special Deluxe, Special Deluxe Plus, Ultra, Deluxe, Utility, Utility Plus, Air, Cordless, and Push-Pull.

B-Line Tools: The B-Line was designed to compete against the best European and Asian imported tools. It stands out because it surpasses competitive tools with the integration of Albion's legendary quality, state-of-the-art engineering and yet with the cost savings of an import. The tools in this category include: B1, B12, B18, and B26.

Commodity Line Tools: Commodity Line tools are designed to complete a simple job and are commonly purchased at hardware, paint, and DIY stores. Our strength lies in providing you with a more consistent quality. The tools in this category are: H10, R6, and R5.

Albion ENGINEERING Tidbit™

"While other USA companies also provide imported tools, Albion is unique because the tools are shipped first to its USA manufacturing plant. There they enter a rigorous inspection process conducted by engineers who designed and built the Professional Line of Tools."

FACT: Caulking Gun Drives are Just Like the Gears of a Racing Bike:

Just as you would never choose the same bicycle gear for a level road as you would a steep hill, choose the correct caulking gun drive based on the thickness of the material you are dispensing and the length of the nozzle.

When you need to climb a steep hill on a bicycle you are thankful to have low output (high-thrust) gears. Think of dispensing a high viscosity product, like cold urethane or two-part epoxy, like a big hill to be climbed. Your speed in the low gear is decreased, but you can still handle the higher work load comfortably. Long nozzles (over 6") present a similar challenge. You need to gear-down to handle the work load.

When you are cycling a flat stretch of road (analogous to a dispensing a lower viscosity caulk like silicone or acrylic latex), you will be frustrated with that low gear - you are spinning your cranks (pulling the trigger) too easily and your output is low. You need to switch back to a higher gear (lower thrust gun drive) for higher output.

So choose your dispensing tool power based on the material and application - the same way you would choose the gear on your bike based on the terrain.

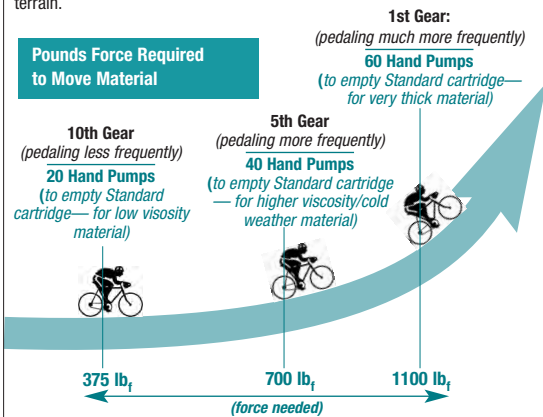

DRIVES

Relationships Between Drive Systems, Force (thrust), and Pressures (PSI) within the Material Containment Unit (MCU). Below is a standard “engineering” equation which shows the relationship between the Force generated (required) by the drive system and the pressure within the MCU. Note the decrease in pressure as the barrel diameter increases.

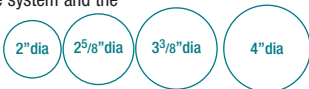

$$F \text{ (force)} = P \text{ (pressure)} \times A \text{ (area)}$$

(force): generated by Drive (pressure): in Material Containment Unit (area): surface area of piston

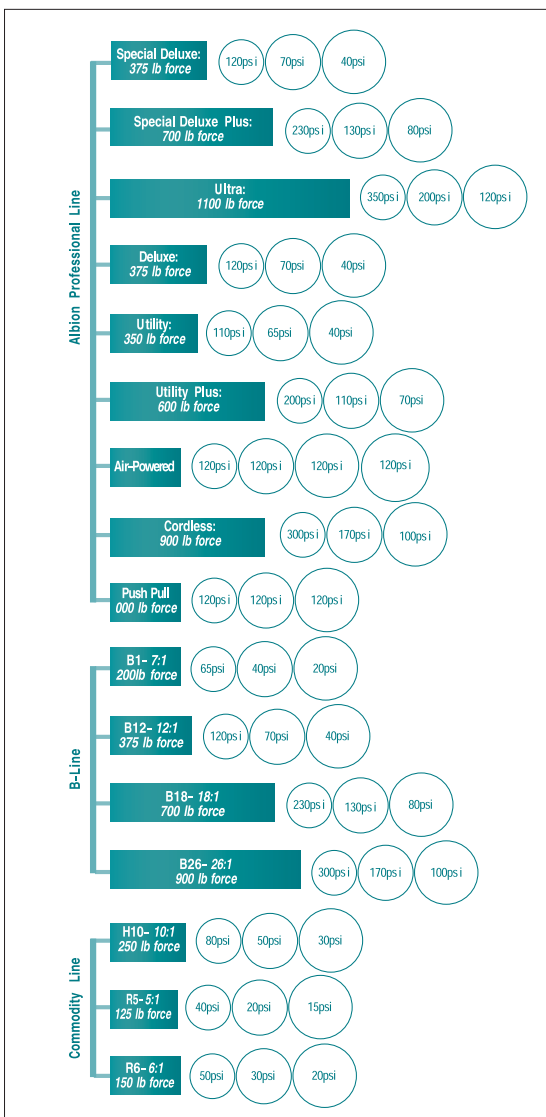

DRIVES

Albion Professional Line

Special Deluxe Line of Manual Drives



Special Deluxe Manual Drive



Special Deluxe Plus Manual Drive



Ultra Manual Drive

Special Deluxe:

- ✓ 375 lb force
- ✓ generally used by waterproofers & glaziers

Special Deluxe Plus:

- ✓ 700 lb force

Ultra Manual Drive:

- ✓ 2 speeds: 1100 lb force and 375 lb force

Special Deluxe, Special Deluxe Plus, and Ultra Manual Drives—

Models are built for daily heavy-duty use and offer the best combination of price and performance.

Standard Drive features: • reinforced construction for high-pressure applications • welded heavy gauge steel • Albion quality • epoxy-coated handles for comfort and corrosion resistance • T-pulls with 5/16"

Special Deluxe Manual Drive:

- 375 lb force

square smooth rod

Special Deluxe Plus Manual Drive:

- 700 lb force
- double the power of a Special Deluxe Drive

Ultra Manual Drive:

- 1100 lb force
- nearly 4 times the power of a Special Deluxe Drive

Albion Professional Line

Deluxe Manual Drives



Deluxe Manual Drive

Models are built for moderate daily use and offer a good combination of price and performance.

- ✓ 375 lb force
- ✓ 1/4" square smooth piston rod that rotates for 4 times longer life
- ✓ thumb activated instant pressure release
- ✓ formed steel construction and corrosion resistant zinc plating with solvent resistant leather piston
- ✓ the roofers' and framers' tool

Deluxe Manual Drive:

- 375 lb force

DRIVES

Albion Professional Line

Utility Manual Drives

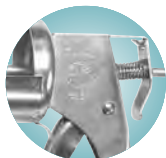

Utility
Manual Drive

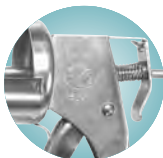

Utility Plus
Manual Drive

Utility Manual Drive:

- ✓ 350 lb force
- ✓ the adhesive tool

Utility Plus Manual Drive:

- ✓ 600 lb force, almost twice the thrust of the Utility Drive with minimal added cost

Utility and Utility Plus Manual Drives—

Models for lighter duty use.

Standard Drive features:

- 5/16" round smooth rod
- heavy gauge steel and zinc plating
- fast acting 3-prong clip on cap
- durable coil springs
- Albion quality
- built for moderate use
- more durable than the average professional tool

Utility Manual Drive:

- 350 lb force

Utility Plus Manual Drive:

- 600 lb force
- double the power of a Utility Drive

Albion Professional Line

Push Pull



Push Pull
Manual Drive

- ✓ a dispensing tool without a drive
- ✓ manual load and unload; pull back to load, push to dispense
- ✓ a lower cost alternative for quickly dispensing low viscosity fluids or priming equipment
- ✓ excellent for large volume applications where control is not an issue
- ✓ uses the same durable replaceable components as a Special Deluxe Tool

Albion ENGINEERING Tidbit™

Single Action Air Guns—

- Air power allows for smooth dispensing
- Manual load improves speed and quality
- Its simplicity improves reliability
- Air pressure = material containment pressure

Dual Action Air Guns—

- Air power in both dispensing and loading directions
- Commonly used on two component applications
- Best for experienced users

DRIVES

B-Line

Manual Drives



B1 Manual Drive

B12 Manual Drive

B18 Manual Drive

B26 Manual Drive

B1, B12, B18, and B26 Line Manual Drives—

- USA engineered with the savings of an import

B1 Manual Drive:

- ✓ 1/10 gallon cartridge
- ✓ excellent value
- ✓ light, flexible, easy to operate
- ✓ high output for low viscosity materials
- ✓ smooth, consistent, **drip free** application
- ✓ orange powder coated
- ✓ stores flat in a tool box, out of the way

B12 Manual Drive:

- ✓ 12:1 Drive (Standard power ratio)
- ✓ Albion's Double-Gripping Plate technology for double the life of the tool
- ✓ Albion's adjustable wear compensation device for no-loss trigger motion
- ✓ smooth action and comfortable grip
- ✓ slotted front cap for easy loading
- ✓ equipped with ladder hook pull

B18 Manual Drive:

- ✓ 18:1 drive for medium viscosity materials
- ✓ all the features of a B12

B26 Manual Drive:

- ✓ 26:1 Drive
- ✓ all features of the B12
- ✓ high-performance applicator
- ✓ easily handles high-viscosity materials and use in cold weather

B1 Manual Drive:

- 200 lb force
- handymans tool

B12 Manual Drive:

- 375 lb force
- all around tool

B18 Manual Drive:

- 700 lb force
- more power

B26 Manual Drive:

- 900 lb force
- high thrust for thick materials

Albion ENGINEERING Tidbit™

Why Ratchet and Smooth Rod Caulking Guns:

* Ratchet Rod tools were the first tools built to dispense caulk. They were, and still are, great tools for dispensing low viscosity (watery) materials and when multiple short applications are used.

* In 1933 Albion invented and patented the Smooth Rod Caulking Gun—enabling the caulker to do long applications with little or no imperfections. In other words, a Smooth Rod Caulking Gun provides a smoother bead of caulk.

* Some Smooth Rod Caulking Guns have been designed so that they don't drip after dispensing. What the designers have really done is create a Smooth Rod caulking Gun that acts like a ratchet gun— an evolution toward the past... .

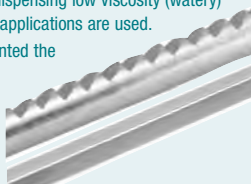

DRIVES

Viper Line

Manual Drives



H10
Manual Drive

H10, R5, and R6 Manual Drives—

• Albion's commodity line features true imported tools. Albion engineers all of their commodity tools and maintains a high level of consistent quality from its supplier.



H10 Manual Drive:

- ✓ 10:1 power ratio
- ✓ smooth hex rod
- ✓ nozzle cutter and puncture wire
- ✓ easy, out-of-the-way storage with its light, flat design



R5
Manual Drive



R6
Manual Drive

R5 and R6 Manual Drives—

• Excellent for low cost sealants and applications where there is a significant amount of start and stops, due to the inherent drip-free design of a ratchet drive. Nozzle cutter and puncture wire.

R5 Manual Drive:

- ✓ 5:1 power ratio
- ✓ disposable, low usage tool

R6 Manual Drive:

- ✓ 6:1 power ratio

Albion Professional Line

Air-Powered Drives



Single Action
Air Drive Drive

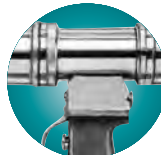

Dual Action
Air-Powered Drive



AT Dual
Action Drive

Single Action and Dual Action Air-Powered Drives—

Unlike a Manual tool, an air-powered gun has a few unique qualities.

- to regulate the flow of material, simply adjust the air pressure regulator
- manual force is not required to create pressure within the MCU
- the thickness of the material and the pressure supplied determine the speed of material dispensing

Single Action Air-Powered Drive:

- ✓ air power allows for smooth dispensing
- ✓ manual loading improves speed and quality
- ✓ its simplicity improves reliability

Dual Action Air-Powered Drive:

- ✓ air power in both dispensing and loading directions

AT Dual Action Air-Powered Drive:

- ✓ large 4" air cylinder for fast dispensing of twin cartridge material
- ✓ ergonomic suitcase handle

BATTERY POWERED DISPENSING TOOLS

Cordless Guns with State-of-the-art Performance, Portability, and Control



- **Fully Assembled**— ready to go right out of the box
- **Heavy Duty**— all-metal gear box develops 900 lbs force, *three times the power of most manual guns*; composite carriage strongest in the industry
- **Total Dispensing Control**— set maximum speed rate and fine tune with variable speed trigger
- **High Productivity**— as incredible as this seems, a joint 1/4" x 1/8" and the length of a football field can be filled in less than 2 minutes; with a rod speed of 23 inches per minute, jobs get done faster
- **Power Efficient**— dispense over 185 latex 10 oz cartridges or over 60 cold urethane 10 oz cartridges on one charge (compact battery)
- **Ergonomic**— design greatly reduces trigger-hand fatigue and wrist strain
- **No Drip**— instant drive disengagement
- **18 Volt Battery**— Lithium-ion performs at full power until drained; included with 30 minute fast charger
- **Easy Conversion**— kits available for easy conversion to cartridge, bulk, or sausage dispensing
- **Compatibility**— accepts all Albion air and manual accessories



photo provided by: United Professional Caulking & Restoration, Inc.

How Fast is Fast! A Cordless Gun can dramatically decrease the amount of time on a work site. For example a DL-59-T13E with a 2" barrel can fill a 1/4 inch x 1/8 inch joint the length of a football field in less than 2 minutes.

That's greater than 150 feet per minute. And unlike an air-powered tool, there are no hoses to get in the way. Albion's Cordless guns are the only tools that can consistently perform to such high standards for extended periods of time. Below is a Standard Usage Chart contractors refer to when estimating the amount of material needed for a specific job. By knowing the width and depth of a joint, a contractor can then calculate the number of feet possible from a single gallon of material. The next chart, "How Fast is Fast", shows how many feet of material can be applied per minute using an Albion battery powered tool.

standard material usage chart	depth of joint	Usage Chart for Standard Sealant based on one gallon:							
		← width of joint →							
		1/4"	1/2"	3/4"	1"	1 1/4"	1 1/2"	1 3/4"	2"
1/8"	616 ft								
1/4"		154 ft							
3/8"			68 ft						
1/2"				39 ft	31 ft	26 ft	22 ft	19 ft	

How Fast is Fast?
How about filling a joint the length of a football field in less than two minutes! See the chart below.

speed	model	Installation Speeds with a Cordless Drive:							
		← width of joint →							
		1/4"	1/2"	3/4"	1"	1 1/4"	1 1/2"	1 3/4"	2"
DL-59-T13E 2" Barrel Diameter	193 ft per minute	48 ft per minute	21 ft per minute	12 ft per minute	10 ft per minute	8 ft per minute	7 ft per minute	6 ft per minute	
770-20E 2 5/8" Barrel Diameter	332 ft per minute	83 ft per minute	37 ft per minute	21 ft per minute	17 ft per minute	14 ft per minute	12 ft per minute	10 ft per minute	
103-15E 3 3/8" Barrel Diameter	549 ft per minute	137 ft per minute	61 ft per minute	34 ft per minute	27 ft per minute	23 ft per minute	20 ft per minute	17 ft per minute	

10oz-80oz BULK GUNS

10oz BULK GUNS (1/10 Gallon) & VARIATIONS

BULK

Our Most Popular Models

DL-24-Core Guns



DL-24-T13A (Air-Powered)



DL-24-T13E (Cordless Drive)



DL-24-T13 (Manual Drive)

The Professional's Preferred Choice

Model	Description	Thrust	Pressure
-------	-------------	--------	----------

Core Tools

These Albion guns are commonly used by the serious professional for multiple applications

- Tools utilize leather pistons instead of plastic pistons, enabling them to accept a wider range of materials and provide a much improved performance
- All metal barrel guns are designed to also accept standard 1/10 gallon cartridges (A 29-5 ejector is required for ease of application)

✓ DL-24-T13	Special Deluxe Manual Gun <i>(see page 10 for Drive information)</i>	375 lb _f	120 psi
	<ul style="list-style-type: none"> • steel barrel for durability • standard 1/2 inch round metal nozzle 		
DL-24-T13A	Air-Powered Gun (previously 100-12)	* →	120 psi
	<i>(see page 13 for Drive information)</i>		
	<ul style="list-style-type: none"> • manual pull allows user better loading sensitivity • optional regulator enables better flow control 		
DL-24-T13E	Cordless Gun (battery powered)	900 lb _f	300 psi
	<i>(see page 14 for Drive information)</i>		
	<ul style="list-style-type: none"> • fast— 20 seconds at full speed to dispense entire load • power— 3 times the thrust of a standard manual drive • flow control— instant drive disengagement • ergonomic design— reduces wrist strain • dispensing control— adjustable trigger speed • duration— 150+ loads on one charge • includes— (1) 18 volt Lithium-ion battery; 30 minute charger & Hytrel piston • Lithium-ion battery supplies full power until totally drained • fully assembled— ready to go right out of the box 		

*** when ordering any cordless gun without battery & charger add an "N" to the end of the part number

10oz-80oz **BULK GUNS** & VARIATIONS

BULK

10oz VARIATIONS: Tools built for unique applications

* Barrel Type * Thrust * Nozzles * Clip Caps * Price * Special Applications

Model	Description	Thrust	Pressure
-------	-------------	--------	----------

10oz Barrel Type Variations

- Aluminum (see page 7 for Barrel information)

DL-24-T33	Special Deluxe Manual Gun	375 lb _f	120 psi
DL-24-T33E	Cordless Gun	900 lb _f	300 psi



Special Deluxe Plus



Ultra

10oz Thrust Variations

- Special Deluxe Plus & Ultra for extremely thick material (see page 9 for Thrust and page 10 for Drive information)

Special Deluxe Plus Drive Manual Guns Double the thrust of a standard drive

DL-24-T13P	Steel barrel	700 lb _f	240 psi
DL-24-T33P	Aluminum barrel	700 lb _f	240 psi

Ultra Drive Manual Guns Four times the thrust of a standard drive

DL-24-T13U	Steel barrel (previously UL-24-T13)	1100 lb _f	360 psi
DL-24-T33U	Aluminum barrel	1100 lb _f	360 psi



10oz Nozzle Variations

- (3) 235-3 Orange Cone nozzles and (1) 421-G01 Ring Cap replaces (1) 426-G01 Front Cap and (1) 32-55 1/2 inch round nozzle

Steel Barrel Guns (see page 7 for Barrel information)

DL-24-T17	Special Deluxe Manual Gun	375 lb _f	120 psi
DL-24-T17A	Air-Powered Gun	* →	120 psi
DL-24-T17E	Cordless Gun	900 lb _f	300 psi

Aluminum Barrel Guns (see page 7 for Barrel information)

DL-24-T37	Special Deluxe Manual Gun	375 lb _f	120 psi
DL-24-T37E	Cordless Gun	900 lb _f	300 psi



10oz Clip Cap Variations

- 1/4 Turn Clip Cap replaces Standard Thread cap. Easy on/off— (Threaded caps improve seal and reduce the tendency of leakage; extra care is required with clip cap tools) 26-6 replaces 426-G01 standard cap

DL-24C	Deluxe Manual Gun	375 lb _f	120 psi
--------	-------------------	---------------------	---------

10oz-80oz **BULK GUNS** & VARIATIONS

10oz VARIATIONS: Tools built for unique applications

* Barrel Type * Thrust * Nozzles * Clip Caps * Price * Special Applications

BULK

Model **Description** **Thrust** **Pressure**



10oz Price Variations

- It all comes down to how hard and frequently you use a tool; the following are engineered to provide you with the same level of success in the application



B-LINE: incorporates bulk gun USA engineered technology with the savings of an import; guns feature rotating swivel handle, leather pistons and accept all Albion bulk and sausage gun accessories

(see page 12 for Drive information)

B12B10	Manual Gun (12:1 Drive)	375 lb _f	120 psi
B26B10	Manual Gun (26:1 Drive)	900 lb _f	300 psi



10oz Special Applications

- Tools for unique jobs

Dual Directional Air-Powered Gun:

Commonly used in industrial or underwater applications

565-1	Standard Gun	* →	120 psi
-------	--------------	-----	---------

1/10 Gallon Convertible: Deluxe tools assembled as Bulk with Cartridge Convertible Kit included— for special applications cartridges can be used with Bulk Metal Nozzles

DL-810-01	Deluxe Gun - Cartridge/Bulk	375 lb _f	120 psi
DL-810-01E	Cordless Gun - Cartridge/Bulk	900 lb _f	300 psi

Albion ENGINEERING Tidbit™

Bending Nozzles—

Aluminum Bending Nozzles (32-112, 113, and 114) are designed to allow you to customize a nozzle to reach hard to reach areas. They can easily be cut, bent or crimped to make a job a success.



10oz-80oz **BULK GUNS** & VARIATIONS

10oz VARIATIONS: Tools built for unique applications

* Barrel Type * Thrust * Nozzles * Clip Caps * Price * Special Applications

Model	Description	Thrust	Pressure
-------	-------------	--------	----------

Albion ENGINEERING Tidbit™

Dramatically Increase Your Productivity with the New DDT Delamination Detection Tool:

Albion's Delamination Detection Tool, the DDT (p/n 875-1), improves the process of detecting voids with hammers or chains by about 500%. The DDT is safe to use, helps avoid repetitive motion injuries, reduces wrist strain, and prevents ladder accidents.

Conveniently, it adapts to most medium and heavy duty broom sticks and paint poles (available upon request) and accepts standard 3/4" crayon and paint markers for on-the-spot marking of delaminated areas. The surfaces it can be used on include concrete slabs, columns, walls, beams, tile surfaces, and masonry. The DDT is ideal for inspecting wide ranges of surfaces like parking garages, bridge decks, support structures, balconies, and tunnels. For more information visit www.ddt-tool.com.



Albion ENGINEERING Tidbit™

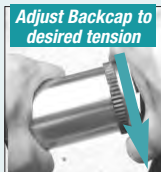

Swiveling Barrel: For applying material in difficult situations, Albion has engineered a special feature that allows the user to adjust the barrel and nozzle 360 degrees. By unloosening the adjustable lock ring, the user can modify the swivel resistance.

BULK

10oz-80oz **BULK GUNS**

20oz **BULK GUNS** (1/2 Pint) & VARIATIONS

BULK

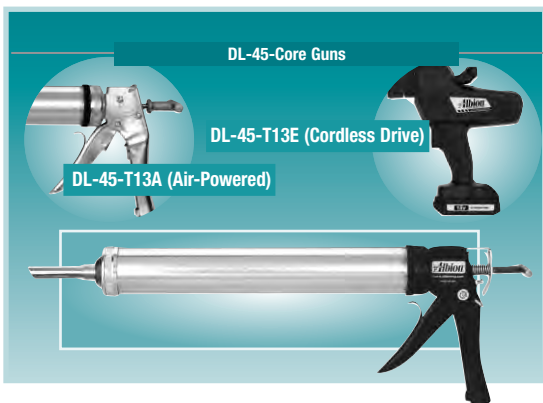

The Professional's Preferred Choice

Model	Description	Thrust	Pressure
-------	-------------	--------	----------

Core Tools

These Albion guns are commonly used by the serious professional for multiple applications

- Tools utilize leather pistons instead of plastic pistons, enabling them to accept a wider range of materials and provide a much improved performance
- All metal barrel guns are designed to also accept standard 1/10 gallon cartridges; (A 29-5 ejector is required for ease of application)

✓ DL-45-T13	Special Deluxe Manual Gun <i>(see page 10 for Drive information)</i> <u>Our most popular model</u> • steel barrel for durability • standard 1/2 inch round metal nozzle	375 lb _f	120 psi
DL-45-T13A	Air-Powered Gun (previously 100-9) * → <i>(see page 13 for Drive information)</i> • manual pull allows user better loading sensitivity • optional regulator enables better flow control		120 psi
DL-45-T13E	Cordless Gun (battery powered) <i>(see page 14 for Drive information)</i> • fast— 30 seconds to dispense entire load at full speed • power— 3 times the thrust of a standard manual drive • flow control— instant drive disengagement • ergonomic design— reduces wrist strain • dispensing control— adjustable trigger speed • duration— 50+ loads on one charge • includes— (1) 18 volt Lithium-ion battery; 30 minute charger • Lithium-ion battery supplies full power until totally drained • fully assembled— ready to go right out of the box	900 lb _f	300 psi

*** when ordering any cordless gun without battery & charger add an "N" to the end of the part number

10oz-80oz **BULK GUNS** & VARIATIONS

20oz VARIATIONS: Tools built for unique applications

* Barrel Type * Thrust * Nozzles * Clip Caps * Price * Special Applications

Model **Description** **Thrust** **Pressure**



Special Deluxe Plus



Ultra

BULK

20oz Thrust Variations

- Special Deluxe Plus & Ultra for extremely thick material
(see page 10 for Thrust information)

Special Deluxe Plus Manual Guns Double the thrust of a standard drive

DL-45-T13P	Steel barrel	700 lb _f	240 psi
DL-45-T23P	Teflon [®] barrel	700 lb _f	240 psi
DL-45-T33P	Aluminum barrel	700 lb _f	240 psi

Ultra Manual Guns Four times the thrust of a standard drive

DL-45-T13U	Steel barrel (previously UL-45-T13)	1100 lb _f	360 psi
DL-45-T23U	Teflon [®] barrel	1100 lb _f	360 psi
DL-45-T33U	Aluminum barrel	1100 lb _f	360 psi

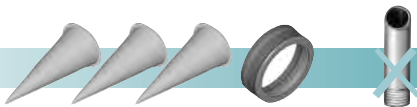

20oz Nozzle Variations

- (3) 235-3 Orange Cone nozzles and (1) 421-G01 Ring Cap replaces (1) 426-G01 Front Cap and (1) 32-55 1/2 inch round nozzle

Steel Barrel Guns (see page 7 for Barrel information)

DL-45-T17	Special Deluxe Manual Gun	375 lb _f	120 psi
440-11	Special Deluxe Manual Gun (32-55 nozzle only)	375 lb _f	200 psi
440-12	Special Deluxe Manual Gun	375 lb _f	200 psi
440-17	Special Deluxe Manual Gun (cone nozzle only)	375 lb _f	200 psi
DL-45-T17A	Air-Powered Gun	* →	120 psi
DL-45-T17E	Cordless Gun	900 lb _f	300 psi

Teflon[®] Barrel Guns (see page 7 for Barrel information)

DL-45-T27	Special Deluxe Manual Gun	375 lb _f	120 psi
DL-45-T27A	Air-Powered Gun	375 lb _f	120 psi
DL-45-T27E	Cordless Gun	900 lb _f	300 psi

Aluminum Barrel Guns (see page 7 for Barrel information)

DL-45-T37	Special Deluxe Manual Gun	375 lb _f	120 psi
DL-45-T37E*	Cordless Gun	900 lb _f	300 psi

440 Series guns are special kits. All bulk versions have 222-2 expanders in the leather pistons and a 416-G01 hook pull. Most have both 235-3 cone nozzles (w/421-G01 cap) and a 33-55 metal nozzle (w/426-G01 cap). See notes for exceptions. Sold only through distributors. Minimum order quantity is 96 guns.

10oz-80oz **BULK GUNS** & VARIATIONS

20oz VARIATIONS: Tools built for unique applications

* Barrel Type * Thrust * Nozzles * Clip Caps * Price * Special Applications

Model	Description	Thrust	Pressure
20oz Barrel Type Variations			
<ul style="list-style-type: none"> • Teflon® & Aluminum (see page 7 for Barrel information) • Teflon® Barrel; Teflon® coated barrel reduces piston friction; easier to pump and clean 			
DL-45-T23	Special Deluxe Manual Gun	375 lb _f	120 psi
440-21	Special Deluxe Manual Gun (32-55 nozzle only)	375 lb _f	200 psi
440-22	Special Deluxe Manual Gun	375 lb _f	200 psi
440-27	Special Deluxe Manual Gun (cone nozzle only)	375 lb _f	200 psi
DL-45-T23A	Air-Powered Gun	* →	120 psi
DL-45-T23E	Cordless Gun	900 lb _f	300 psi
Aluminum Lighter weight			
DL-45-T33	Special Deluxe Manual Gun	375 lb _f	120 psi
DL-45-T33E	Cordless Gun	900 lb _f	300 psi

1/4 Turn



Thread



20oz Clip Cap Variations

- 1/4 Turn Clip Cap replaces Standard Thread cap; easy on/off—
- (Threaded caps improve seal and reduce the tendency of leakage; extra care is required with clip cap tools); 26-6 replaces 426-G01 standard cap

DL-45C-T13	Special Deluxe Manual Gun	375 lb _f	120 psi
DL-45C-T13P	Special Deluxe Plus Manual Gun	700 lb _f	240 psi
DL-45C-T17	Special Deluxe Manual Gun w/cones (3 orange cones vs standard 1/2 inch nozzle)	375 lb _f	120 psi



DL-45-01

B12B20



B26B20

20oz Price Variations

- It all comes down to how hard and frequently you use a tool; the following are engineered to provide you with the same level of success in the application

DELUXE LINE: Excellent midrange tool; square rod technology; customizable—accepts all Albion pistons, nozzles, & barrels; replacement parts available

(see page 10 for Drive information)

DL-45-01	Deluxe Manual Gun	375 lb _f	120 psi
----------	-------------------	---------------------	---------



B-LINE: incorporates bulk gun USA engineered technology with the savings of an import; guns feature rotating swivel handle, leather pistons and accept all Albion bulk and sausage gun accessories

(see page 12 for Drive information)

B12B20	Manual Gun (12:1 Drive)	375 lb _f	120 psi
B26B20	Manual Gun (26:1 Drive)	900 lb _f	300 psi

10oz-80oz **BULK GUNS** & VARIATIONS

BULK

20oz VARIATIONS: Tools built for unique applications

* Barrel Type * Thrust * Nozzles * Clip Caps * Price * Special Applications

Model	Description	Thrust	Pressure
-------	-------------	--------	----------

20oz Special Applications

- Tools for unique jobs

746-2



Dual Directional Air-Powered Gun: Commonly used in industrial or underwater applications

746-2	Standard Gun	* →	120 ps
-------	--------------	-----	--------

PD-45-T17



Push Pull Gun: Best for thin materials where loading and unloading can be accomplished by hand

PD-45-T17	Push Pull Gun with cone nozzle (3 orange cones vs standard 1/2 inch nozzle)	* →	30 psi
-----------	--	-----	--------



703-G11



862-G02

Extension Guns: Crack guide pin to improve control & adjustable wheel assembly for comfortable upright dispensing; excellent for traffic detector inductance loops, pavement expansion joints, and roof membrane lap joints

703-G11	Special Deluxe Manual Gun	375 lb _f	120 psi
700-G01	Air-Powered Extension Gun	* →	120 psi
862-G02	Manual, Air, or Cordless Ext. Gun Kit (fits DL-59-T13 [Manual], DL-59-T13A [Air], and DL-59-T13E [Cordless] tools)	375 lb _f	120 psi

Albion **ENGINEERING Tidbit™**

Standard Leather Piston Packing Replacements—

All Bulk models come equipped with the standard Soft Leather Cup.



- Recommended for general purpose applications and to improve dispensing performance.
- Flexible, long-lasting, and durable— easily handles harsh abrasives and solvents.
- Best all-around chemical resistance.

To customize your tools for specific types of adhesives and sealants see **SYNTHETIC UPGRADES**. (page 79 for more details.)

Required Maintenance: Leathers must be soaked in light weight oil between cleanings to retain their sealing properties.

part 21-1	2 inch diameter piston
part 21-8	2 ⁵ / ₈ inch diameter piston
part 21-4	3 ⁵ / ₈ inch diameter piston

10oz-80oz BULK GUNS

30oz BULK GUNS (1 Quart) & VARIATIONS

BULK

Our Most Popular Models

DL-59-Core Guns



DL-59-T13A (Air-Powered)



DL-59-T13E (Cordless Drive)



DL-59-T13 (Manual Drive)

The Professional's Preferred Choice

Model	Description	Thrust	Pressure
-------	-------------	--------	----------

Core Tools

These Albion guns are commonly used by the serious professional for multiple applications

- Tools utilize leather pistons instead of plastic pistons, enabling them to accept a wider range of materials and provide a much improved performance
- All metal barrel guns are designed to also accept standard 1/10 gallon cartridges (A 29-5 ejector is required for ease of application)

✓ DL-59-T13	Special Deluxe Manual Gun <i>Our most popular model</i>	375 lb _f	120 psi
	<ul style="list-style-type: none"> • steel barrel for durability with standard 1/2 inch round metal nozzle 		
DL-59-T13A	Air-Powered Gun. (previously 100-10) <i>(see page 13 for Drive information)</i>	* →	120 psi
	<ul style="list-style-type: none"> • manual pull allows user better loading sensitivity • optional regulator enables better flow control 		
DL-59-T13E	Cordless Gun. (battery powered)	900 lb _f	300 psi
	<ul style="list-style-type: none"> • fast— 35 seconds to dispense entire load at full speed • power— 3 times the thrust of a standard manual drive • flow control— instant drive disengagement • ergonomic design— reduces wrist strain • dispensing control— adjustable trigger speed • duration— 50+ loads on one charge • includes— (1) 18 volt Lithium-ion battery; fast 30 minute charger • Lithium-ion battery supplies full power until totally drained • fully assembled— ready to go right out of the box 		

*** when ordering any cordless gun without battery & charger add an "N" to the end of the part number

10oz-80oz BULK GUNS

30oz VARIATIONS: Tools built for unique applications

* Barrel Type * Thrust * Nozzles * Clip Caps * Price * Special Applications

Model	Description	Thrust	Pressure
30oz Barrel Type Variations			
• Teflon® & Aluminum (see page 7 for Barrel information)			
Teflon® Barrel	Teflon® coated barrel reduces piston friction & eases cleaning		
DL-59-T23	Special Deluxe Manual Gun	375 lb _f	120 psi
440-24	Special Deluxe Manual Gun	375 lb _f	120 psi
DL-59-T23A	Air-Powered Gun (similar to 100-10)	* →	120 psi
DL-59-T23E	Cordless Gun	900 lb _f	300 psi
Aluminum	Lighter weight		
DL-59-T33	Special Deluxe Manual Gun	375 lb _f	120 psi
DL-59-T33E	Cordless Gun	900 lb _f	300 psi

1/4 Turn



Thread



30oz Clip Cap Variations

- 1/4 Turn Clip Cap replaces Standard Thread cap. Easy on/off—
- (Threaded caps improve seal and reduce the tendency of leakage; extra care is required with clip cap tools); 26-6 replaces 426-G01 standard cap

DL-59C-T13	Special Deluxe Manual Gun	375 lb _f	120 psi
DL-59C-T13P	Special Deluxe Plus Manual Gun	700 lb _f	240 psi

Special Deluxe Plus



Ultra



30oz Thrust Variations

- Special Deluxe Plus & Ultra for extremely thick material (see page 10 for Thrust information)

Special Deluxe Plus Manual Guns Double the thrust of a standard drive

DL-59-T13P	Steel barrel	700 lb _f	240 psi
DL-59-T23P	Teflon® barrel	700 lb _f	240 psi
DL-59-T33P	Aluminum barrel	700 lb _f	240 psi

Ultra Manual Guns Four times the thrust of a standard drive

DL-59-T13U	Steel barrel (previously UL-59-T13)	1100 lb _f	360 psi
DL-59-T23U	Teflon® barrel (previously UL-59-T23)	1100 lb _f	360 psi
DL-59-T33U	Aluminum barrel	1100 lb _f	360 psi

10oz-80oz BULK GUNS

30oz VARIATIONS: Tools built for unique applications

* Barrel Type * Thrust * Nozzles * Clip Caps * Price * Special Applications

BULK

Model **Description** **Thrust** **Pressure**



30oz Nozzle Variations

- (3) 235-3 Orange Cone nozzles and (1) 421-G01 Ring Cap replaces (1) 426-G01 Front Cap and (1) 32-55 1/2 inch round nozzle

Steel Barrel Guns *(see page 7 for Barrel information)*

DL-59-T17	Special Deluxe Manual Gun	375 lb _f	120 psi
440-14	Special Deluxe Manual Gun	375 lb _f	120 psi
DL-59-T17A	Air-Powered Gun	* →	120 psi
DL-59-T17E	Cordless Gun	900 lb _f	300 psi

Teflon Barrel Guns *(see page 7 for Barrel information)*

DL-59-T27	Special Deluxe Manual Gun	375 lb _f	120 psi
440-24	Special Deluxe Manual Gun	375 lb _f	120 psi
DL-59-T27A	Air-Powered Gun	375 lb _f	120 psi
DL-59-T27E	Cordless Gun	900 lb _f	300 psi

Aluminum Barrel Guns *(see page 7 for Barrel information)*

DL-59-T37	Special Deluxe Manual Gun	375 lb _f	120 psi
DL-59-T37E	Cordless Gun	900 lb _f	300 psi

440 Series guns are special kits. All bulk versions have 222-2 expanders in the leather pistons and a 416-G01 hook pull. Most have both 235-3 cone nozzles (w/421-G01 cap) and a 33-55 metal nozzle (w/426-G01 cap). See notes for exceptions. Sold only through distributors. Minimum order quantity is 96 guns.



30oz Price Variations

- It all comes down to how hard and how frequently you use a tool; the following are engineered to provide you with the same level of success in the application



B-LINE: incorporates bulk gun USA engineered technology with the savings of an import; guns feature rotating swivel handle, leather pistons and accept all Albion bulk and sausage gun accessories

(see page 2 for Drive information)

B12B30	Manual Gun (12:1 Drive)	375 lb _f	120 psi
B26B30	Manual Gun (26:1 Drive)	900 lb _f	300 psi
B12B30W	Manual Gun (12:1 Drive) (with neoprene piston (p/n 21-16) for water based products)	375 lb _f	120 psi

10oz-80oz BULK GUNS

30oz VARIATIONS: Tools built for unique applications

* Barrel Type * Thrust * Nozzles * Clip Caps * Price * Special Applications

Model	Description	Thrust	Pressure
-------	-------------	--------	----------

30oz Special Applications

- Tools for unique jobs



Large Diameter Barrel: 25/8" Diameter. Note: as barrel diameter increases, pressure drops compared to a 2" barrel

770-20	Special Deluxe Manual Gun	375 _f	60 psi
770-20P	Special Deluxe Plus Manual Gun	700 _f	130 psi
770-20E	Cordless Gun	900 _f	170 psi



Dual Directional Air-Powered Gun: Commonly used in industrial or underwater applications

624-1	Standard Gun	* →	120 psi
-------	--------------	-----	---------



Push Pull Gun: Best for thin materials where loading and unloading can be accomplished by hand

PD-59-T17	Push Pull Gun with cone nozzle (3 orange cones vs standard 1/2 inch nozzle)	* →	30 psi
-----------	--	-----	--------



Extension Guns: Crack guide pin to improve control & adjustable wheel assembly for comfortable upright dispensing; excellent for traffic detector inductance loops, pavement expansion joints, and roof membrane lap joints

703-G12	Special Deluxe Manual Gun	375 lb _f	120 psi
700-G02	Air-Powered Gun	* →	120 psi
862-G02	Extension Gun Kit	375 lb _f	120 psi

(fits DL-59-T13 [Manual], DL-59-T13A [Air], and DL-59-T13E [Cordless] tools)

BULK

45oz BULK GUNS

45oz BULK GUNS (1½ Quart) & VARIATIONS

BULK

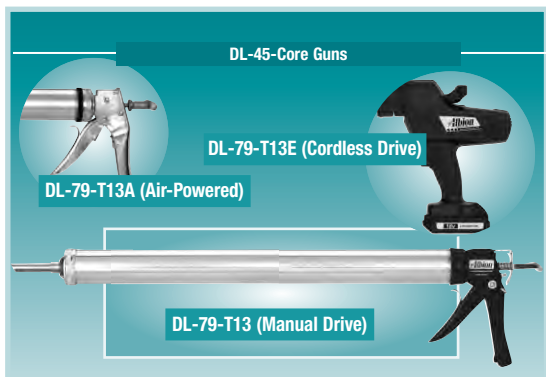

The Professional's Preferred Choice

Model	Description	Thrust	Pressure
-------	-------------	--------	----------

Core Tools

These Albion guns are commonly used by the serious professional for multiple applications

- Tools utilize leather pistons instead of plastic pistons, enabling them to accept a wider range of materials and provide a much improved performance
- 25" long barrel for floor joints or difficult to reach areas

✓ DL-79-T13	Special Deluxe Manual Gun <i>(see page 10 for Drive information)</i>	375 lb _f	120 psi
	<ul style="list-style-type: none"> • steel barrel for durability • standard 1/2 inch round metal nozzle 		
DL-79-T13A	Air-Powered Gun <i>(see page 13 for Drive information)</i>	*→	120 psi
	<ul style="list-style-type: none"> • manual pull allows user better loading sensitivity • optional regulator enables better flow control 		
DL-79-T13E	Cordless Gun (battery powered) <i>(see page 14 for Drive information)</i>	900 lb _f	300 psi
	<ul style="list-style-type: none"> • fast— 65 seconds to dispense entire load at full speed • power— 3 times the thrust of a standard manual drive • flow control— auto reverse when trigger released • ergonomic design— reduces wrist strain • dispensing control— adjustable trigger speed • duration— 25+ loads on one charge • includes— (1) 18 volt Lithium-ion battery; fast 30 minute charger • Lithium-ion battery supplies full power until totally drained • fully assembled— ready to go right out of the box 		

*** when ordering any cordless gun without battery & charger add an "N" to the end of the part number

45oz BULK GUNS & VARIATIONS

45oz VARIATIONS: Tools built for unique applications

* Barrel Type * Thrust * Nozzles * Clip Caps * Price * Special Applications

Model	Description	Thrust	Pressure
-------	-------------	--------	----------

700-G03



45oz Special Applications

- Tools for unique jobs

Extension Guns: Crack guide pin to improve control & adjustable wheel assembly for comfortable upright dispensing; excellent for traffic detector inductance loops, pavement expansion joints, and roof membrane lap joints

700-G03	Air-Powered Extension Gun	* →	120 psi
---------	---------------------------	-----	---------

Albion ENGINEERING Tidbit™

LADDER HOOK PULLS—

Albion Bulk, Sausage, and Cartridge guns accept Ladder Hook Pulls that conveniently hang for ready use. Simply screw on to the piston rod of any Albion model.



Aluminum: 310-1

Steel: 416-G01

Steel: 310-2



BULK

80oz BULK GUNS

80oz BULK GUNS (2 1/2 Quart) & VARIATIONS

BULK

DL-75 Guns

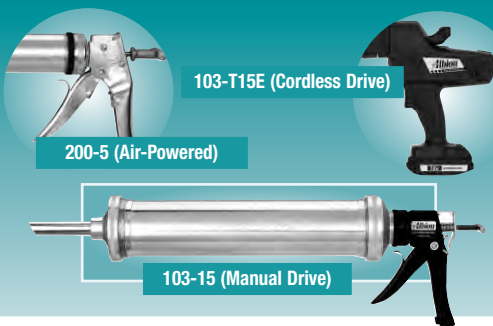

The Professional's Preferred Choice

Model	Description	Thrust	Pressure
-------	-------------	--------	----------

Core Tools

These Albion guns are commonly used by the serious professional for multiple applications

- Tools utilize leather pistons instead of plastic pistons, enabling them to accept a wider range of materials and provide a much improved performance

✓ 103-15	Special Deluxe Manual Gun (see page 10 for Drive information) • steel barrel for durability • jumbo 3/4 inch round metal nozzle	375 lb _f	50 psi
200-5	Air-Powered Gun (see page 14 for Drive information) • manual pull allows user better loading sensitivity. • optional regulator enables better flow control	↔ →	120 psi
103-15E	Cordless Gun (battery powered) (see page 1 for Drive information) • fast— 30 seconds to dispense entire load at full speed • power— 3 times the thrust of a standard manual drive • flow control— instant drive disengagement • ergonomic design— reduces wrist strain • dispensing control— adjustable trigger speed • duration— 25+ loads on one charge • includes— (1) 18 volt Lithium-ion battery; fast 30 minute charger & leather piston • Lithium-ion battery supplies full power until totally drained • fully assembled— ready to go right out of the box	900 lb _f	100 psi

*** when ordering any cordless gun without battery & charger add an "N" to the end of the part number

80oz BULK GUNS & VARIATIONS

80oz VARIATIONS: Tools built for unique applications

* Barrel Type * Thrust * Nozzles * Clip Caps * Price * Special Applications

Model	Description	Thrust	Pressure
-------	-------------	--------	----------

80oz Thrust Variations

- Special Deluxe Plus & Ultra for extremely thick material (see page 10 for Thrust information)

Special Deluxe Plus Manual Guns Double the thrust of a standard drive

103-15P	Steel barrel	700 lb _f	100 psi
103-16P	Steel barrel w/cones (3 orange cones vs standard 1/2 inch nozzle)	700 lb _f	100 psi

Ultra Manual Guns Four times the thrust of a standard drive

103-15U	Steel barrel	1100 lb _f	150 psi
103-16U	Steel barrel with cones (3 orange cones vs standard 1/2 inch nozzle)	1100 lb _f	150 psi



80oz Nozzle Variations

- (3) 235-3 Orange Cone nozzles and (1) 421-G01 Ring Cap replaces (1) 426-G01 Front Cap and (1) 32-55 1/2 inch round nozzle

Steel Barrel Guns (see page 7 for Barrel information)

103-16	Special Deluxe Manual Gun	375 lb _f	50 psi
200-7	Air-Powered Gun	* →	120 psi

733-G11

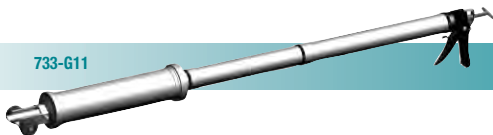

80oz Special Applications

- Tools for unique jobs

Extension Guns: Crack guide pin to improve control & adjustable wheel assembly for comfortable upright dispensing; excellent for traffic detector inductance loops, pavement expansion joints, and roof membrane lap joints

733-G11	Special Deluxe Manual Gun	375 lb _f	50 psi
720-G01	Air-Powered Extension Gun	* →	120 psi

BULK

10oz SAUSAGE GUNS

10oz SAUSAGE GUNS & VARIATIONS

DL-24-Core Guns



DL-24-T14A (Air-Powered)



DL-24-T14E (Cordless Drive)



DL-24-T14 (Manual Drive)

SAUSAGE

The Professional's Preferred Choice

Model	Description	Thrust	Pressure
-------	-------------	--------	----------

Core Tools

These Albion guns are commonly used by the serious professional for multiple applications

- All steel barrel for durability

✓ **DL-24-T14** **Special Deluxe Manual Gun** 375 lb_f 120 psi
(see page 10 for Drive information)

- steel barrel for durability
- standard 1/2 inch round metal nozzle.

DL-24-T14A **Air-Powered Gun** (previously 100-10) * → 120 psi
(see page 13 for Drive information)

- Teflon[®] piston (see page 84 for Piston Information)
- optional regulator enables better flow control

DL-24-T14E **Cordless Gun** (battery powered) 900 lb_f 300 psi

- fast— 30 seconds to dispense entire load at full speed
- power— 3 times the thrust of a standard manual drive
- flow control— instant drive disengagement
- ergonomic design— reduces wrist strain
- dispensing control— adjustable trigger speed
- (3) 235-3 orange cones instead of the standard 1/2 inch round nozzle
- duration— 150+ loads on one charge 
- includes— (1) 18 volt Lithium-ion battery; fast 30 minute charger & Hytrel piston
- Lithium-ion battery— supplies full power until totally drained
- fully assembled— ready to go right out of the box

*** when ordering any cordless gun without battery & charger add an "N" to the end of the part number

Albion ENGINEERING Tidbit™

Polyfinger Pistons:

When care of tools is an issue this piston was designed to be replaced after a few days of application. Low cost replacement pistons are available (47-39)



10oz SAUSAGE GUNS & VARIATIONS

10oz VARIATIONS: Tools built for unique applications

* Piston * Barrel Type * Thrust * Price * Special Applications

Model **Description** **Thrust** **Pressure**

10oz Price Variations

- Just like with the B-Line Series, it all comes down to how hard and how frequently you use a tool; the following are engineered to provide you with the same level of success in the application

DL-24-02



DELUXE LINE: Excellent midrange tool; square rod technology; customizable—accepts all Albion pistons, nozzles, & barrels; replacement parts available

(3) 235-3 Orange cones instead of the standard 1/2 inch round nozzle (see page 2 for Drive information)

DL-24-02	Deluxe Manual Gun w/Teflon Piston	375 lb _f	120 psi
DL-24-05	Deluxe Manual Gun w/Polyfinger Piston	375 lb _f	120 psi

SAUSAGE



B12S10

B26S10



B-LINE: incorporates bulk gun USA engineered technology with the savings of an import; guns feature rotating swivel handle, quick change front cap; included with each gun are (3) narrow nozzles, (3) cones, and (2) extra pistons

(see page 12 for Drive information)

B12S10	Manual Gun (12:1 Drive)	375 lb _f	120 psi
B26S10	Manual Gun (26:1 Drive)	900 lb _f	300 psi

Polyfinger



Hytrel



10oz Piston Variations

Polyfinger or Hytrel. (see page 79 for piston information.)

Polyfinger Piston: • low cost piston option designed for one or two day use; replacement packets available, p/n 47-39. (10 pack). • (3) 235-3 Orange cones instead of the standard 1/2 inch round nozzle.

Steel Barrel

DL-24-T15	Special Deluxe Manual.	375 lb _f	120 psi
DL-24-T15A	Air-Powered (previously 100-14)	* →	120 psi

Aluminum Barrel

DL-24-T35	Special Deluxe Manual.	375 lb _f	120 psi
-----------	------------------------	---------------------	---------

Hytrel Piston: • stiff piston designed to scrape barrel walls.

Steel Barrel

DL-24-T18	Special Deluxe Manual.	375 lb _f	120 psi
-----------	------------------------	---------------------	---------

20oz SAUSAGE GUNS

20oz SAUSAGE GUNS & VARIATIONS

DL-45-Core Guns



SAUSAGE

The Professional's Preferred Choice

Model	Description	Thrust	Pressure
-------	-------------	--------	----------

Core Tools

These Albion guns are commonly used by the serious professional for multiple applications

✓ DL-45-T14	Special Deluxe Manual Gun (see page 10 for Drive information) <ul style="list-style-type: none"> • steel barrel for durability • standard 1/2 inch round metal nozzle. 	375 lb _f	120 psi
DL-45-T14A	Air-Powered Gun (previously 100-10) (see page 13 for Drive information) <ul style="list-style-type: none"> • Teflon[®] piston (see page 84 for Piston Information) • optional regulator enables better flow control 	* →	120 psi
DL-45-T14E	Cordless Gun (battery powered) <ul style="list-style-type: none"> • fast— 30 seconds to dispense entire load at full speed • power— 3 times the thrust of a standard manual drive • flow control— instant drive disengagement • ergonomic design— reduces wrist strain • dispensing control— adjustable trigger speed • (3) 235-3 orange cones instead of the standard 1/2 inch round nozzle • duration— 150+ loads on one charge • includes— (1) 18 volt Lithium-ion battery; fast 30 minute charger & Hytrel piston • Lithium-ion battery— supplies full power until totally drained • fully assembled— ready to go right out of the box 	900 lb _f	300 psi



*** when ordering any cordless gun without battery & charger add an "N" to the end of the part number

20oz SAUSAGE GUNS & VARIATIONS

20oz VARIATIONS: Tools built for unique applications

* Piston * Barrel Type * Thrust * Price * Special Applications

Model **Description** **Thrust** **Pressure**

20oz Price Variations

- It all comes down to how hard and frequently you use a tool; the following are engineered to provide you with the same level of success in the application

DL-45-02



DELUXE LINE: Excellent midrange tool; square rod technology; customizable—accepts all Albion pistons, nozzles, & barrels; replacement parts available.

(3) 235-3 Orange cones instead of the standard 1/2 inch round nozzle.

(see page 10 for Drive information.)

DL-45-02 Deluxe Manual Gun w/**Teflon**® Piston 375 lb_f 120 psi

DL-45-05 Deluxe Manual Gun w/Polyfinger Piston 375 lb_f 120 psi



B-LINE: incorporates bulk gun USA engineered technology with the savings of an import; guns feature rotating swivel handle, leather pistons and accept all Albion bulk and sausage gun accessories; includes spare bulk piston

(see page 12 for Drive information)

B12S20 Manual Gun (12:1 Drive) 375 lb_f 120 psi

B18S20 Manual Gun (18:1 Drive) 700 lb_f 230 psi

B26S20 Manual Gun (26:1 Drive) 900 lb_f 300 psi

20oz Special Applications

- Tools for unique jobs

746-1



Dual Directional Air-Powered Gun:

Commonly used in industrial or underwater applications

746-1 Standard Gun * → 120 psi

703-G15

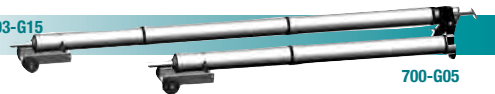

Extension Guns: Crack guide pin to improve control & with adjustable wheel assembly for comfortable upright dispensing; excellent for traffic detector inductance loops, pavement expansion joints, and roof membrane lap joints

703-G15 Special Deluxe Manual Gun 375 lb_f 120 psi

700-G05 Air-Powered Gun * → 120 psi

862-G02 Manual, Air, or Cordless Extension Kit 375 lb_f 120 psi
(fits DL-59-T13 [Manual], DL-59-T13A [Air], and DL-59-T13E [Cordless] tools)

20oz SAUSAGE GUNS & VARIATIONS

20oz VARIATIONS: Tools built for unique applications

* Piston * Barrel Type * Thrust * Price * Special Applications

Model **Description** **Thrust** **Pressure**

20oz Barrel Type Variations

- **Teflon** & Aluminum (see page 7 for Barrel information)
- **Teflon Barrel**; Teflon coated barrel reduces piston friction; easier to pump and clean

DL-45-T24	Special Deluxe Manual Gun	375 lb _f	120 psi
440-26	Special Deluxe Manual Gun (Teflon® piston)	375 lb _f	200 psi
DL-45-T24A	Air-Powered Gun	* →	120 psi
DL-45-T24E	Cordless Gun	900 lb _f	300 psi

- **Aluminum** Lighter weight

DL-45-T34	Special Deluxe Manual Gun	375 lb _f	120 psi
DL-45-T34E	Cordless Gun	900 lb _f	300 psi

SAUSAGE

Polyfinger



Hytrel



20oz Piston Variations

Polyfinger or Hytrel. (see page 79 for piston information.)

Polyfinger Piston: • low cost piston option designed for one or two day use; replacement packets available, p/n 47-39. (10 pack). • (3) 235-3 Orange cones instead of the standard 1/2 inch round nozzle

Steel Barrel

DL-45-T15	Special Deluxe Manual Gun	375 lb _f	120 psi
DL-45-T15A	Air-Powered (previously 100-13)	* →	120 psi

Hytrel Piston: • stiff piston designed to scrape barrel walls.

Steel Barrel

DL-45-T18	Special Deluxe Manual Gun	375 lb _f	120 psi
DL-45-T18A	Air-Powered Gun	* →	120 psi

440 Series guns are special kits. All bulk versions have 222-2 expanders in the leather pistons and a 416-G01 hook pull. Most have both 235-3 cone nozzles (w/421-G01 cap) and a 33-55 metal nozzle (w/426-G01 cap). See notes for exceptions. Sold only through distributors. Minimum order quantity is 96 guns.

Albion ENGINEERING Tidbit™

LADDER HOOK PULLS—

Albion Bulk, Sausage, and Cartridge guns accept Ladder Hook Pulls that conveniently hang for ready use. Simply screw on to the piston rod of any Albion model.



Aluminum: 310-1

Steel: 416-G01

Steel: 310-2



20oz SAUSAGE GUNS & VARIATIONS

20oz VARIATIONS: Tools built for unique applications

* Piston * Barrel Type * Thrust * Price * Special Applications

Model Description Thrust Pressure



Special Deluxe Plus



Ultra

20oz Thrust Variations

- Special Deluxe Plus & Ultra for extremely thick material (see page 9 for Thrust information)

Special Deluxe Plus Manual Guns

Double the thrust of a standard drive

DL-45-T14P	Steel barrel	700 lb _f	240 psi
DL-45-T24P	Teflon [®] barrel	700 lb _f	240 psi
DL-45-T34P	Aluminum barrel	700 lb _f	240 psi

Ultra Manual Guns

Four times the thrust of a standard drive

DL-45-T14U	Steel barrel (previously UL-59-T13)	1100 lb _f	360 psi
DL-45-T24U	Teflon [®] barrel (previously UL-59-T23)	1100 lb _f	360 psi
DL-45-T34U	Aluminum barrel	1100 lb _f	360 psi

20oz Nozzle Variations

- (3) 235-3 Orange Cone nozzles and (1) 33-55 Metal nozzle
- | | | | |
|--------|--------------|---------------------|---------|
| 440-16 | Steel Barrel | 375 lb _f | 120 psi |
|--------|--------------|---------------------|---------|

Albion ENGINEERING Tidbit™



Swiveling Barrel: For applying material in difficult situations, Albion has engineered a special feature that allows the user to adjust the barrel and nozzle 360 degrees. By unloosening the adjustable lock ring, the user can modify the swivel resistance.

10oz CARTRIDGE GUNS

10oz CARTRIDGE GUNS & VARIATIONS

846-1 Core Guns



846-1A (Air-Powered)



846-1E (Cordless Drive)



846-1 (Manual Drive)

The Professional's Preferred Choice

CARTRIDGE

Model	Description	Thrust	Pressure
-------	-------------	--------	----------

Core Tools

These Albion guns are commonly used by the serious professional for multiple applications

✓ 846-1	Special Deluxe Manual Gun <i>(see page 10 for Drive information)</i>	375 lb _f	120 psi
	<ul style="list-style-type: none"> • durability— composite carriage means added strength • easy applications— carriage swivels • square rod— 4 times the life of a standard rod 		
846-1A	Air-Powered Gun (previously 360-1) * →		120 psi
	<ul style="list-style-type: none"> • full barrel containment— improved air seal and safety • optional regulator— better flow control 		
846-1E	Cordless Gun *** (battery powered) <i>(see page 14 for Drive information)</i>	900 lb _f	300 psi
	<ul style="list-style-type: none"> • fast— 20 seconds to dispense entire load at full speed • power— 3 times the thrust of a standard manual drive • flow control— instant drive disengagement • ergonomic design— reduces wrist strain • dispensing control— adjustable trigger speed • duration— 180+ loads on one charge • includes— (1) 18 volt Lithium-ion battery; fast 30 minute charger • Lithium-ion battery supplies full power until totally drained • fully assembled— ready to go right out of the box 		

*** when ordering any cordless gun without battery & charger add an "N" to the end of the part number

Albion ENGINEERING Tidbit™

Special Cartridge Nozzles

Green Nozzle 6 1/2" overall length, 45 degree bent spout for hard to reach areas.

- fits over 1/10 gallon cartridges

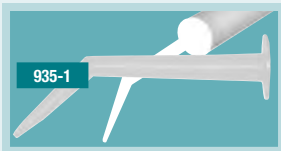

935-1

10oz CARTRIDGE GUNS & VARIATIONS

10oz VARIATIONS: Tools built for unique applications

* Metal Carriage * Thrust * Full Barrel * B-Line * Hex & Ratchet Rod * Extension Guns

Model	Description	Thrust	Pressure
783-2			
380-5			
139-3			
370-3			

10oz Metal Carriage Variations

- Light and strong, legendary durable metal carriage
- Out of the way puncture wire included
(see page 10 for Drive information)

783-2	Swivel Carriage Special Deluxe Gun	375 lb _f	120 psi
380-5	Black Epoxy Powder Coated Special Deluxe Gun	375 lb _f	120 psi
139-3	Plated Special Deluxe Gun <i>(Our most popular Gun in its class)</i>	375 lb_f	120 psi
370-3	1/2 Barrel Utility Gun <i>(USA manufactured round rod tool)</i>	375 lb _f	120 psi

CARTRIDGE



10oz Thrust Variations

- Special Deluxe Plus & Ultra for extremely thick material
(see page 10 for Thrust information)

Special Deluxe Plus Manual Guns Double the thrust of a standard drive

846-1P	Composite carriage	700 lb _f	240 psi
380-5P	Metal carriage	700 lb _f	240 psi

Ultra Manual Guns Four times the thrust of a standard drive

846-1U	Composite carriage	1100 lb _f	360 psi
380-5U	Metal carriage	1100 lb _f	360 psi

10oz CARTRIDGE GUNS & VARIATIONS

10oz VARIATIONS: Tools built for unique applications

* Metal Carriage * Thrust * Full Barrel * B-Line * Hex & Ratchet Rod * Extension Guns

Model	Description	Thrust	Pressure
-------	-------------	--------	----------

DL-24C



10oz Full Barrel Variations

- Designed to be adaptable with many of Albion's metal nozzles for special applications

DL-24	Deluxe Manual Gun	375 lb _f	120 psi
DL-24C	Deluxe Manual Gun w/1/4 turn Clip Cap	375 lb _f	120 psi
DL-810-01	Deluxe Convertible Manual Gun <i>(used for Cartridge & Bulk applications)</i>	375 lb _f	120 psi

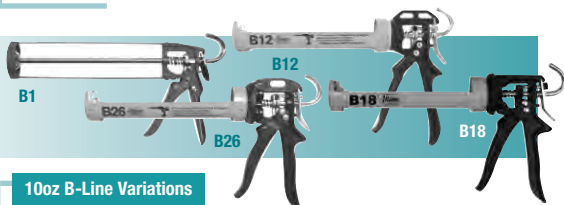

10oz B-Line Variations

- It all comes down to how hard and frequently you use a tool; the following are engineered to provide you with the same level of success in the application



B-LINE: incorporates USA engineered technology with the savings of an import

(see page 12 for Drive information)

B1	Manual Skeleton Gun (7:1 Drive) no drip	200 lb _f	65 psi
B12	Manual Gun (12:1 Drive)	375 lb _f	120 psi
B18	Manual Gun (18:1 Drive)	700 lb _f	230 psi
B26	Manual Gun (26:1 Drive)	900 lb _f	300 psi

Albion ENGINEERING Tidbit™

Why Ratchet and Smooth Rod Caulking Guns:

* Ratchet Rod tools were the first tools built to dispense caulk. They were, and still are, great tools for dispensing low viscosity (watery) materials and when multiple short applications are used.

* In 1933 Albion invented and patented the Smooth Rod Caulking Gun— enabling the caulker to do long applications with little or no imperfections. In other words, a Smooth Rod Caulking Gun provides a smoother bead of caulk.

* Some Smooth Rod Caulking Guns have been designed so that they don't drip after dispensing. What the designers have really done is create a Smooth Rod caulking Gun that acts like a ratchet gun— an evolution toward the past...



10oz CARTRIDGE GUNS & VARIATIONS

10oz VARIATIONS: Tools built for unique applications

* Metal Carriage * Thrust * Full Barrel * B-Line * Hex & Ratchet Rod * Extension Guns

Model **Description** **Thrust** **Pressure**

10oz Hex Rod & Ratchet Rod Variations



H10



H10D



- **Hex Rod:** commonly used in the paint and DIY markets
(see page 13 for Drive information)

H10	Manual Skeleton Gun (10:1 Drive) w/seal punch tool; spout cutter; ladder hook	250 lb _f	80 psi
H10D	Manual Skeleton Gun (10:1 Drive) w/no drip; seal punch tool; spout cutter; ladder hook	250 lb _f	80 psi
H10XD	Manual Half Barrel (10:1 Drive) w/no drip; seal punch tool; spout cutter; ladder hook	250 lb _f	80 psi

R5



R6B



- **Ratchet Rod:** simple Ratchet tools commonly used in paint, DIY and retail industries
(see page 13 for Drive information)

R5	Manual Half Barrel Gun (5:1 Drive) w/seal punch tool; spout cutter; ladder hook	125 lb _f	40 psi
R6B	Manual Half Barrel Gun (6:1 Drive) w/seal punch tool; spout cutter; ladder hook; wrist strap	150 lb _f	50 psi

10oz Extension Variations

400-G01

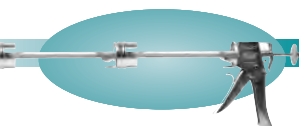

Kit (P/N 395-G07)



- 24" Extension gun eliminates the need for hard to pump long nozzles and is ideal for most materials. Add additional 8" increments (p/n 395-G07) to extend reach
(see page 10 for Drive information)

400-G01 Deluxe Manual Gun

Albion ENGINEERING Tidbit™



Adjustment Screws Mean Longer Tool Life:

B-Line Tools are engineered to a higher level. For example, Albion's adjustment tool technology means increased life of the gun— as the tool wears you can adjust the screw to remove the wasted motion.

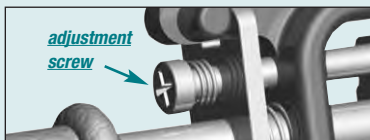

adjustment screw

28oz CARTRIDGE GUNS

28oz CARTRIDGE GUNS & VARIATIONS



The Professional's Preferred Choice

Model	Description	Thrust	Pressure
-------	-------------	--------	----------

Core Tools

These Albion guns are commonly used by the serious professional for multiple applications

✓ 405-15	Special Deluxe Manual Gun (see page 10 for Drive information) <i>Our most popular model</i>	375 lb _f	60 psi
405-15A	Air-Powered Gun. (previously 365-2 * →) (see page 13 for Drive information)		120 psi
405-15E	Cordless Gun.*** (battery powered) (see page 14 for Drive information)	900 lb _f	170 psi

- durability— steel carriage means added strength
- easy applications— carriage swivels
- square rod— 4 times the life of a standard round rod
- full barrel containment— improved air seal and safety
- optional regulator— better flow control
- fast— 35 seconds to dispense entire load at full speed
- power— three times the thrust of a standard manual drive
- flow control— instant drive disengagement
- ergonomic design— reduces wrist strain
- dispensing control— adjustable trigger speed
- duration— 50+ loads on one charge
- includes— (1) 18 volt Lithium-ion battery; fast 30 minute charger
- Lithium-ion battery supplies full power until totally drained
- fully assembled— ready to go right out of the box

*** when ordering any cordless gun without battery & charger add an "N" to the end of the part number

Albion ENGINEERING Tidbit™

Cove Base Nozzles:

Albion offers 3 Cove Base Premium and 3 Cove Base Standard nozzles. Nozzles are all-metal construction with steel parts zinc plated for corrosion resistance.

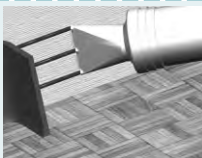

28oz CARTRIDGE GUNS & VARIATIONS

28oz VARIATIONS: Tools built for unique applications

* Metal Carriage * Thrust * Full Barrel * B-Line * Hex & Ratchet Rod * Extension Guns

Model **Description** **Thrust** **Pressure**

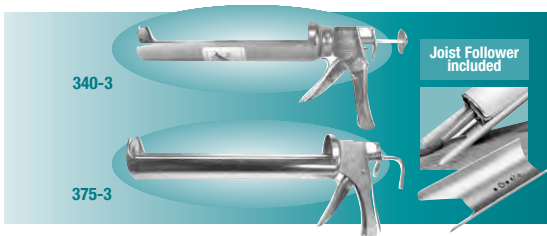

28oz Metal Carriage Variations

- Light and strong, legendary durable metal carriage
- Guns come with Joist Follower (p/n 802-G01) inset, that adjusts for surface variations with spout length
- Out of the way puncture wire included (see page 10 for Drive information)

340-3	Deluxe Manual Gun	375 lb _f	70 psi
375-3	Utility Manual Gun	350 lb _f	65 psi

405-15P



28oz Thrust Variations

- Special Deluxe Plus for extremely thick material (see page 10 for Thrust information)

Special Deluxe Plus Manual Guns Double the thrust of a standard drive
 405-15P Standard gun w/ Swivel Metal Carriage 700 lb_f 130 psi

770-18

770-17



28oz Full Barrel Variations

- Designed to be adaptable with many of Albion's metal nozzles for special applications (see page 74 for Nozzle information)

Standard Nozzle

770-18	Special Deluxe Manual Gun	375 lb _f	60 psi
770-18A	Air-Powered Gun	→	120 psi
770-18E	Cordless Gun	900 lb _f	170 psi

Cove Base Nozzle

770-17	Special Deluxe Manual Gun	375 lb _f	60 psi
770-17A	Air-Powered Gun	→	120 psi
770-17E	Cordless Gun	900 lb _f	170 psi

CARTRIDGE

28oz CARTRIDGE GUNS & VARIATIONS

28oz VARIATIONS: Tools built for unique applications

* Metal Carriage * Thrust * Full Barrel * B-Line * Hex & Ratchet Rod * Extension Guns

Model	Description	Thrust	Pressure
-------	-------------	--------	----------



28oz B-Line Variations

- It all comes down to how hard and frequently you use a tool; the following are engineered to provide you with the same level of success in the application
- Guns feature rotating swivel handle, wear compensation device



B-LINE: incorporates bulk gun USA engineered technology with the savings of an import
(see page 1 for Drive information)

B12Q	Manual Gun (12:1 Drive)	375 lb _f	50 psi
B26Q	Manual Gun (26:1 Drive)	900 lb _f	150 psi

28oz Hex Rod & Ratchet Rod Variations



- **Ratchet Rod:** simple Ratchet tools commonly used in paint, DIY and retail industries

(see page 13 for Drive information)

R6BQ	Half Barrel Manual Gun (6:1 Drive)	150 lb _f	25 psi
------	------------------------------------	---------------------	--------

w/seal punch tool; spout cutter; ladder hook, wrist strap

- **Hex Rod:** commonly used in the paint and DIY markets

(see page 13 for Drive information)

H10Q	Manual Skeleton Gun (10:1 Drive)	250 lb _f	50 psi
------	----------------------------------	---------------------	--------

w/seal punch tool; spout cutter; ladder hook

28oz Extension Variations

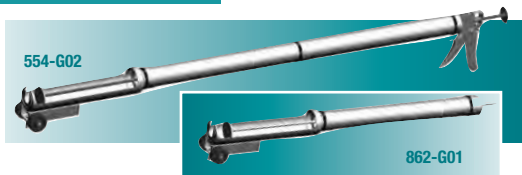

- Pre-assembled; kits assembled onto any DL-59 tool

(see page 10-13 for Drive information)

704-G11	Special Deluxe Manual Gun	375 lb _f	50 psi
554-G02	Deluxe Manual Gun	375 lb _f	50 psi
702-G01	Air-Powered Extension Gun	→	120 psi
862-G01	Manual, Air, or Cordless Extension Kit	375 lb _f	50 psi

(fits DL-59-T13 [Manual], T13 [Air], and T13E [Cordless] tools)

MULTI-COMPONENT GUNS

Technical Reference Information

Review “how to build a gun” (page 5) with an emphasis on the high powered drives. The break down is the same for two component tools — nozzle, MCU, and drive.

Nozzle: The nozzle actually mixes the two materials together; therefore, the material containment unit requires more pressure to generate the flow out of the nozzle. Generally speaking, more elements in a mixer or smaller size increases pressure. (The material manufacturer carefully selects and specifies the nozzle required for their material to obtain a proper mix. Variation from that specification is not recommended.)

Material Containment Unit: The material manufacturer selects the specific cartridges which properly fit their material and the application. Be aware that:

- The face of cartridges and their size determine the proper tool category.
- Larger size cartridges are more economical, but they make the gun system heavier and the material exponentially harder to dispense.

(Force=Pressure X Area)

Drive: The increased number of variables makes selecting a drive system far more critical. Be aware that:

- Thick material requires a high thrust drive system. Manual tools need more pumps for the material to flow.
- Air guns require a larger air cylinder to generate the dispensing force and flow rate.
- Cordless tools must be carefully matched up with the application.

Throughout the catalog the force and material containment unit pressures are listed with each tool. In this section it is important to compare tools and the pressures they generate.

For example: Material packaged in 300x300ml and 750x750ml cartridges, which to select? The pressure required in the MCU to dispense the material is the same. Then:

750x750 ml System requires a 778-1U gun which can generate 81 psi

300x300 ml System requires a 505-9U gun which can generate 205psi

The best system changes in relation to the viscosity:

Thick — the 300x300ml System

Thin — the 750x750ml System

FACT: Caulking Gun Drives are Just Like the Gears of a Racing Bike:

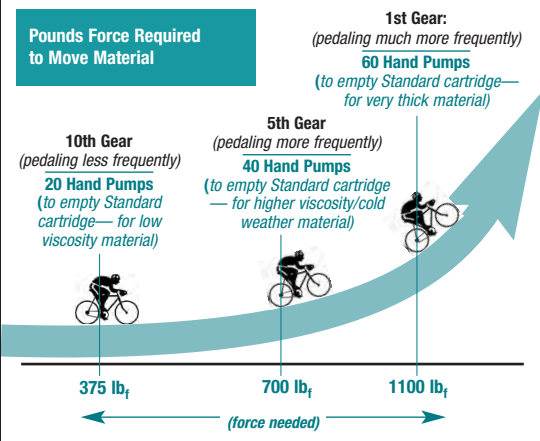

MULTI-COMPONENT

MULTI-COMPONENT GUNS

Bayonet Style Cartridge Specifications

Unique characteristics of the cartridges in this category:

- Designed to easily slide into a dispensing tool and to be held rigidly
- Sturdy one piece design with solid multi-seal pistons.(50cc)
- Static mixers specific to cartridge style and material are required to ensure proper mix

50ml Cartridges: Compact package (cartridge length $4\frac{27}{32}$ inches); tools are generally small and compact; most popular tools are the Composite Gun (871-1) and the R-Line Gun (R6T50i)

Note: the view below is an example, but not exclusively a representation of the cartridge face

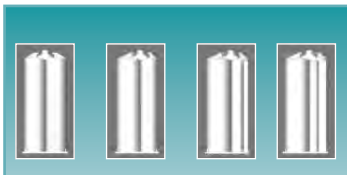

Cartridge Ratio:	1:1	2:1	4:1	10:1
Outside Diameters (in.):	$\frac{27}{32} \times \frac{27}{32}$	$\frac{31}{32} \times \frac{23}{32}$	$\frac{31}{32} \times \frac{1}{2}$	$\frac{31}{32} \times \frac{11}{32}$

180ml (6oz), 240ml (8oz), and 360ml (12oz) Cartridges: Unique application cartridges similar to the 50cc cartridges; known cartridges are all 1:1 ratio, $1\frac{1}{4}$ inches in diameter

Note: the view below is an example, but not exclusively a representation of the cartridge face

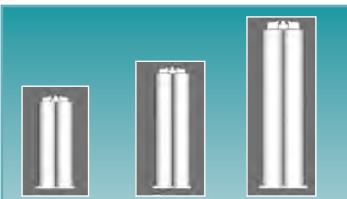

Cartridge Volume:	180ml/6oz	240ml/8oz	360ml/20oz
Outside Lengths (in.):	$6\frac{1}{2}$	$8\frac{15}{16}$	$10\frac{1}{4}$

Static Mixers (see page 64): Static mixers are designed specifically to materials packaged in the cartridges; in order to ensure you select the correct static mixer for your application you will need to contact either the material manufacturer or Albion by phone or e-mail



When choosing the correct static mixer for a specific application there are many variables to take into consideration: material being dispensed, volume of material per application, and how well the two materials mix with each other; in addition, Static mixers are available in round or square configurations, diameters, lengths, and varying elements

MULTI-COMPONENT

MULTI-COMPONENT GUNS

Bayonet Style Cartridges



960-1 (Single Action Air-Powered)



550-1 (Dual Action Air-Powered)



600-1 (Manual Utility)



535-1 (Manual Utility)

The Professional's Preferred Choice

Ratio	Model	Description	Thrust	Pressure ⁺
-------	-------	-------------	--------	-----------------------

Core Tools

These Albion guns are commonly used by the serious professional for two component applications

50ml Cartridges:

✓ 1:1	600-1	Manual Utility Gun	375 lb _f	420 psi
	960-1	Single Action Air-Powered Gun		

180ml (6oz) Cartridges:

1:1	535-1	Manual Utility Gun	375 lb _f	180 psi
	550-1	Dual Action Air-Powered Gun		

240ml (8oz) Cartridges:

1:1	535-2	Manual Utility Gun	375 lb _f	180 psi
	550-2	Dual Action Air-Powered Gun		

360ml (12oz) Cartridges:

1:1	535-3	Manual Utility Gun	375 lb _f	180 psi
	550-3	Dual Action Air-Powered Gun		

MULTI-COMPONENT

Albion ENGINEERING Tidbit™

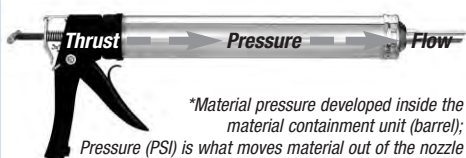

MULTI-COMPONENT GUNS & VARIATIONS

BAYONET STYLE CARTRIDGE VARIATIONS: Tools built for unique applications

* B-Line * Composite * R-Line

Ratio Model Description Thrust Pressure*

B26T360



B-Line Variations

- Incorporating USA engineered technology with the savings of an import; guns feature full carriage containment units

180ml (6oz) Cartridges:

1:1 B26T180 Manual Gun (26:1 Drive) 900 lb_f 450 psi

240ml (8oz) Cartridges:

1:1 B26T240 Manual Gun (26:1 Drive) 900 lb_f 450 psi

360ml (12oz) Cartridges:

1:1 B26T360 Manual Gun (26:1 Drive) 900 lb_f 450 psi

871-1



R6T50i



Our most popular model in its class.

Composite Variations

- Compact light weight Ratchet gun, well balanced versatile tool

50ml Cartridges:

1:1 871-1 50ml Manual Gun 140 lb_f 150 psi

2:1

4:1 871-2 50ml Manual Gun 140 lb_f 150 psi

10:1 871-3 50ml Manual Gun 140 lb_f 200 psi

R-Line Variations

- low cost simple Ratchet gun with full retainers holding the cartridge securely in place for accurate dispensing

50ml Cartridges:

1:1 R6T50i Manual Gun 180 lb_f 200 psi

2:1

4:1

10:1 R6T50iX10 Manual Gun 180 lb_f 270 psi

MULTI-COMPONENT

MULTI-COMPONENT GUNS & VARIATIONS

Albion ENGINEERING Tidbit™

Adjustment Screws Mean Longer Tool Life:



B-Line Tools are engineered to a higher level; for example, Albion's adjustment tool technology means increased life of the gun—as the tool wears you can adjust the screw to remove the wasted motion

adjustment screw

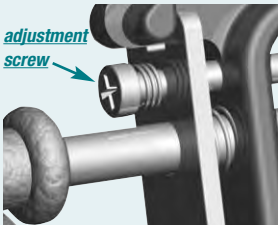

Albion ENGINEERING Tidbit™

Dramatically Increase Your Productivity with the New DDT Delamination Detection Tool:

Albion's Delamination Detection Tool, the DDT (p/n 875-1), improves the process of detecting voids with hammers or chains by about 500%; the DDT is safe to use, helps avoid repetitive motion injuries, reduces wrist strain, and prevents ladder accidents; conveniently, it adapts to most medium and heavy duty broom sticks and paint poles (available upon request) and accepts standard 3/4" crayon and paint markers for on-the-spot marking of delaminated areas; the surfaces it can be used on include concrete slabs, columns, walls, beams, tile surfaces, and masonry; the DDT is ideal for inspecting wide ranges of surfaces like parking garages, bridge decks, support structures, balconies, and tunnels; for more information visit www.ddt-tool.com



Albion ENGINEERING Tidbit™

A Variable Speed Trigger Offers Additional Fine Tuning Control—

Albion's unique Variable Speed Trigger means complete control during an application; by fine tuning the rate of an application there's truly complete control in creating smooth beads, blending, and ease in applying material around corners



MULTI-COMPONENT

MULTI-COMPONENT GUNS

200 and 400 Series Cartridge Specifications

200 Series (6.5oz) Cartridges: Compact package designed to contain a combined total of 200ml, or 6.5 ounces, of material; the total cartridge length is $5\frac{13}{16}$ inches; the cartridge piston design allows most tools to handle at least two different ratios with no adjustments required; (Most common tool used— B26T200)

Note: the 3/4 view below is an example, but not exclusively a representation of the cartridge face

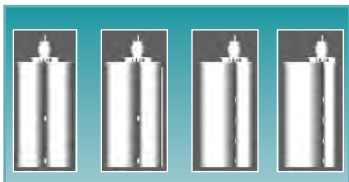

Cartridge Ratio:	1:1	2:1	4:1	10:1
Volume:	100x100	100x50	100x25	100x10
Outside Diameters:	$1\frac{15}{32} \times 1\frac{15}{32}$	$1\frac{23}{32} \times 1\frac{7}{32}$	$1\frac{15}{16} \times 1\frac{31}{32}$	$2\frac{5}{32} \times 2\frac{3}{32}$

400 Series (13.5oz) Cartridges: Compact package designed to contain a combined total of 400ml, or 13.5 ounces, of material; the total cartridge length is $7\frac{3}{4}$ inches; the cartridge piston design allows most tools to handle at least two different ratios with no adjustments required (Most common tool used— B26T400)

Note: the view below is an example, but not exclusively a representation of the cartridge face

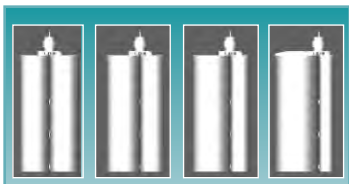

Cartridge Ratio:	1:1	2:1	4:1	10:1
Volume (ml):	200x200	200x100	200x50	200x20
Outside Diameters (in.):	$1\frac{3}{4} \times 1\frac{3}{4}$	$1\frac{1}{16} \times 1\frac{15}{32}$	$1\frac{9}{32} \times 1\frac{15}{32}$	$2\frac{21}{32} \times 2\frac{27}{32}$



Connecting Nut & Static Mixer: see p. 64 for assorted Static Mixer nozzles

MULTI-COMPONENT

Albion ENGINEERING Tidbit™

AT Guns—

The AT line of twin cartridge air guns was developed to address two major short-comings in the marketplace. Ergonomics: New suitcase handle makes one or two hand operation possible with easier and more comfortable dispensing. Quick Exhaust: the fastest in the industry means no material is wasted due to run-on.

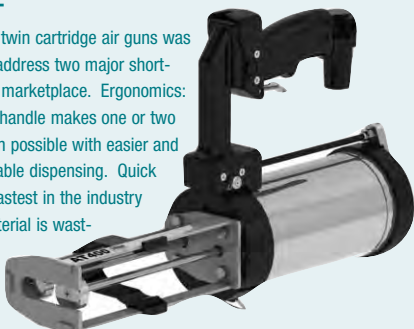

MULTI-COMPONENT GUNS

200 and 400 Series



The Professional's Preferred Choice

Ratio Model Description Thrust Pressure⁺

Core Tools

These Albion guns are commonly used by the serious professional for two component applications

200 Series

1:1	794-1U	Ultra Manual Gun	1100 lb _f	411 psi
2:1			1100 lb _f	401 psi
4:1			1100 lb _f	377 psi
10:1			1100 lb _f	330 psi
1:1	963-1	Dual Action Air-Powered Gun	700 lb _f	262 psi
2:1			700 lb _f	255 psi

400 Series

1:1	937-1U	Ultra Manual Gun	1100 lb _f	284 psi
2:1			1100 lb _f	277 psi
4:1			1100 lb _f	267 psi
10:1			1100 lb _f	221 psi
1:1	AT400	Standard Configuration • Dual Action Air-Powered Gun	1000 lb _f	80 psi
2:1			1000 lb _f	80 psi
4:1	AT400X4	Standard Configuration	1000 lb _f	80 psi
10:1	AT400X10	Standard Configuration	1000 lb _f	80 psi
1:1	AT400-S	Suitcase Configuration	1000 lb _f	80 psi
2:1			1000 lb _f	80 psi
4:1	AT400X4-S	Suitcase Configuration	1000 lb _f	80 psi
10:1	AT400X10-S	Suitcase Configuration	1000 lb _f	80 psi

MULTI-COMPONENT

MULTI-COMPONENT GUNS & VARIATIONS

200 & 400 SERIES VARIATIONS: Tools built for unique applications

* B-Line * Thrust

Ratio Model Description Thrust Pressure*

B26T200



Our most popular model in its class.

200 & 400 Series B-Line Variations

- Incorporating USA engineered technology with the savings of an import; guns feature full carriage containment units

200 Series (6.5oz): our most popular model

1:1	B18T200	Manual Gun (18:1 Drive)	700 lb _f	250 psi
2:1				
1:1	B26T200	Manual Gun (26:1 Drive)	900 lb _f	336 psi
2:1				
4:1	B26T200X4*	Manual Gun (26:1 Drive)	900 lb _f	308 psi
10:1	B26T200X10*	Manual Gun (26:1 Drive)	900 lb _f	232 psi

400 Series (13.5oz): our most popular model

1:1	B26T400	Manual Gun (26:1 Drive)	900 lb _f	270 psi
2:1				
4:1	B26T400X4*	Manual Gun (26:1 Drive)	900 lb _f	218 psi
10:1	B26T400X10*	Manual Gun (26:1 Drive)	900 lb _f	181 psi

* (can dispense 1:1 or 2:1 cartridges) (see p. 50 for Cartridge Specifications)

MULTI-COMPONENT

Special Deluxe Plus



200 & 400 Series Thrust Variations

- Special Deluxe Plus & Utility plus for extremely thick material; see page 10 for Drive information

Special Deluxe Plus Manual Guns Double the thrust of a standard drive

1:1	794-1P	200 Series Manual Gun	700 lb _f	262 psi
2:1				
4:1				
10:1				

Utility Plus Drive Guns Four times the thrust of a standard drive

1:1	857-1P	200 Series Manual Gun	600 lb _f	224 psi
2:1				

(see p. 50 for Cartridge Specifications)

MULTI-COMPONENT GUNS

Albion ENGINEERING Tidbit™

Dramatically Increase Your Productivity with the New DDT Delamination Detection Tool:

Albion's Delamination Detection Tool, the DDT (p/n 875-1), improves the process of detecting voids with hammers or chains by about 500%; the DDT is safe to use, helps avoid repetitive motion injuries, reduces wrist strain, and prevents ladder accidents; conveniently; it adapts to most medium and heavy duty broom sticks and paint poles (available upon request) and accepts standard 3/4" crayon and paint markers for on-the-spot marking of delaminated areas; the surfaces it can be used on include concrete slabs, columns, walls, beams, tile surfaces, and masonry; the DDT is ideal for inspecting wide ranges of surfaces like parking garages, bridge decks, support structures, balconies, and tunnels; for more information visit www.ddt-tool.com

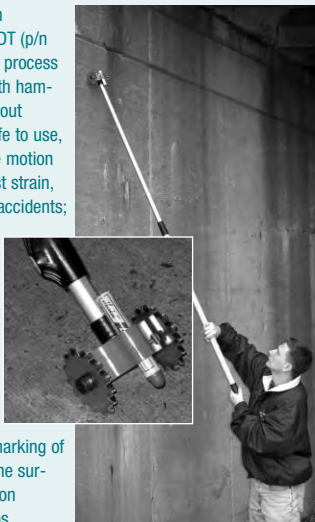

Albion ENGINEERING Tidbit™

Barrel Diameter Affects Pressure:

For example using a Bulk gun with a 25/8" diameter generates 700 lb force, however, if the diameter increases to 33/8" the force drops to 375 lb force; basically the initial force generat-



ed by the drive is spread out over a larger area (diameter) and so the pressure drops accordingly

2" dia

25/8" dia

33/8" dia

Albion ENGINEERING Tidbit™

Rotating Rods: 4 Times the Life



Albion's square smooth drive rod rotates 4 times for longer life than a standard round tool rod

Albion®

MULTI-COMPONENT

MULTI-COMPONENT GUNS

300 Series and "Stubby" Cartridge Specifications

Unique characteristics of the cartridges in this category:

- Either a 2 Piece snap-together or a molded one piece cartridge.
- Outside diameters for the 1:1 are $1\frac{15}{32} \times 1\frac{15}{32}$ inches; outside diameters for the 2:1 are $1\frac{15}{32} \times 1\frac{1}{16}$ inches
- Designed to easily slide into a dispensing tool and to be held rigidly.
- Multiple ratios fit one dispensing tool with no alterations to the tool.
- Require "bell" shape mixer with locking nut. (544-7)

300 Series Cartridges: Compact package designed to contain 10oz, or 300ml (150x150ml), of material or 7.5oz, or 225ml (150x75ml). Cartridge total length $8\frac{1}{2}$ inches. Most common tool used is the B26T300.

"Stubby 150" Cartridges: Compact package designed to contain 5oz, or 150ml (75x75ml), of material. Similar cartridge design but generally a one piece molded design and shorter in length. Total length $4\frac{1}{2}$ inches.

Note: the view below is an example, but not exclusively a representation of the cartridge face



Cartridge Style:

150 Series Cartridge "A":

150 Series Cartridge "B":

"Stubby 150" Cartridge:

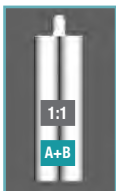

Ratio/ml:

(1:1) 150x150; (2:1) 150x75

(1:1) 150x150; (2:1) 150x75

(1:1) 75x75

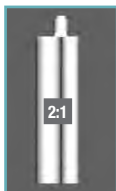

Ratio/Part Number:

(1:1) 741-G03; (2:1) 741-G03

(1:1) 741-G03; (2:1) 741-G05

(1:1) 741-G06



Static Mixer

300 Series

585-1 (Dual Action Air-Powered)



590-4P (Special Deluxe Plus)

The Professional's Preferred Choice

Ratio	Model	Description	Thrust	Pressure ⁺
-------	-------	-------------	--------	-----------------------

Core Tools

These Albion guns are commonly used by the serious professional for two component applications

300 Series

1:1	590-4P	Special deluxe Plus Manual Gun	700 lb _f	257 psi
2:1				
1:1	585-1	Dual Action Air-Powered Gun	700 lb _f	257 psi

MULTI-COMPONENT GUNS & VARIATIONS

300 SERIES VARIATIONS: Tools built for unique applications

* B-Line * Special Applications * Utility Plus

Ratio Model Description Thrust Pressure⁺

B26T300



B18T3000v



300 B-Line Variations

- Incorporating USA engineered technology with the savings of an import; guns feature full carriage containment units

300 Series:

1:1	B18T300	Manual Gun (18:1 Drive)	700 lb _f	257 psi
2:1				
1:1	B26T300	Manual Gun (26:1 Drive)	900 lb _f	330 psi
2:1				
1:1	B18T300V	Manual Gun (18:1 Drive)	700 lb _f	257 psi
2:1				
10:1	B18T330I	Manual Gun (18:1 Drive)	700 lb _f	210 psi

“Stubby 150”:

1:1	B18T150V	Manual Gun (18:1 Drive)	700 lb _f	343 psi
-----	----------	-------------------------	---------------------	---------

(see p. 50 for Cartridge Specifications)

300 Special Applications

- Tools for unique jobs

806-2P



200 and 300 Series:

1:1	806-2P	Utility Plus Manual Gun	600 lb _f	220 psi
-----	--------	-------------------------	---------------------	---------

540-10



Ball Screw Gun Rotary manual motion which generates extreme pressures inside the cartridge.

1:1	540-10	Ball Screw Manual Gun	Extreme
-----	--------	-----------------------	---------

MULTI-COMPONENT

MULTI-COMPONENT GUNS

600 Series Cartridge Specifications

Unique characteristics of the cartridges in this category:

- Either a 2 Piece snap-together or a molded one piece cartridge
- Designed to easily slide into a dispensing tool and to be held rigidly
- Multiple ratios fit one dispensing tool with no alterations to the tool
- Require “bell” shape mixer with locking nut (544-7)

600 Series Cartridges: *Compact package designed to contain multi ratio products; the total cartridge length is 8¹/₂ inches. (Most common tool used is the B26T600)*

Note: the 3/4 view below is an example, but not exclusively a representation of the cartridge face

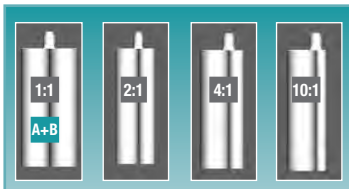
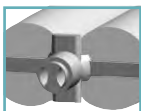

Cartridge Ratio:	1:1	2:1	4:1	10:1
Volume (ml):	300x300ml (22oz)	300x150ml (15oz)	300x75ml (12.5oz)	300x30ml (11oz)
Outside Diameters (in.):	2 x 2	2 x 1 ¹⁵ / ₃₂	2 x 1 ¹ / ₁₆	2 x 3/4
Cartridge Part Number:				
Cartridge “A”	741-G02	741-G02	741-G02	741-G02
Cartridge “B”	741-G02	741-G03	741-G05	741-G06



Connecting Nut & Static Mixer: see p. 64 for assorted Static Mixer nozzles

Albion ENGINEERING Tidbit™

Engineering History—

Albion was founded in 1929 by F. Karl Schneider and in 1935 he patented the first Smooth Rod Drive Caulking Gun; for three generations Albion has been in the forefront of engineering, innovation, and design excellence

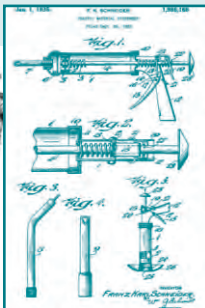

MULTI-COMPONENT GUNS

600 Series



The Professional's Preferred Choice

Ratio	Model	Description	Thrust	Pressure ⁺
-------	-------	-------------	--------	-----------------------

Core Tools

These Albion guns are commonly used by the serious professional for two component applications

600 Series

1:1	505-9U	Ultra Manual Gun	1100 lb _f	205 psi
2:1			1100 lb _f	271 psi
4:1			1100 lb _f	327 psi
1:1	530-5	Dual Action Air-Powered	1000 lb _f	186 psi
2:1			1000 lb _f	245 psi
1:1	AT600	Standard Configuration	1000 lb _f	80 psi
2:1				
1:1	AT600-S	Suitcase Configuration	1000 lb _f	80 psi
2:1				
2:1	AT600X2	Standard Configuration	1000 lb _f	80 psi
2:1	AT600X2-S	Suitcase Configuration	1000 lb _f	80 psi

MULTI-COMPONENT

MULTI-COMPONENT GUNS & VARIATIONS

600 SERIES VARIATIONS: Tools built for unique situations

* B-Line * Thrust * Special Applications

Ratio	Model	Description	Thrust	Pressure
-------	-------	-------------	--------	----------

B26T600



600 B-Line Variations

Incorporating USA engineered technology with the savings of an import; guns feature full carriage containment units

600 Series:

1:1	B26T600	Manual Gun (26:1 Drive)	900 lb _f	167 psi
2:1		<i>Our most popular model</i>	900 lb _f	227 psi*
2:1	B26T600X2	Manual Gun (26:1 Drive)	900 lb _f	222 psi
1:1			900 lb _f	167 psi
4:1	B26T375	Manual Gun (26:1 Drive)	900 lb _f	268 psi
10:1	B18T380i	Manual Gun (18:1 Drive)	700 lb _f	236 psi

505-9U



600 Series Thrust Variations

• Special Deluxe Plus & Utility plus for extremely thick material; see page 10 for Drive information

Special Deluxe Plus Manual Guns Double the thrust of a standard drive

1:1	505-9P	Standard Gun	700 lb _f	130 psi
2:1			700 lb _f	173 psi
4:1			700 lb _f	280 psi

600 Special Applications

• Tools for unique jobs

505-10P



Special Deluxe Plus Manual Guns; Double the thrust of a standard drive. Rods with overhead design; see page 10 for Drive information

1:1	505-10P	Standard Gun	700 lb _f	130 psi
2:1	505-12P	Standard Gun	700 lb _f	173 psi

540-9



Ball Screw Gun Rotary manual motion which generates extreme pressures inside the cartridge

1:1	540-9	Standard Gun		Extreme
2:1				

MULTI-COMPONENT GUNS & VARIATIONS

600 SERIES VARIATIONS: Tools built for unique situations

* B-Line * Thrust * Special Applications

Ratio	Model	Description	Thrust	Pressure
-------	-------	-------------	--------	----------

600 Special Applications: *Tools for unique jobs*



Extension Guns: Stand-up extension guns allow for comfortable dispensing at ground level.

Manual Guns

1:1	B26T600XL	Manual Gun (26:1 Drive)	900 lb _f	167 psi
2:1			900 lb _f	222 psi
2:1	B26T600X2L	Manual Gun (26:1 Drive)	900 lb _f	222 psi
1:1			900 lb _f	167 psi

Air-Powered Guns Designed to use a 200-7 air drive system and a B26T600XL. Components can be purchased separately or as follows:

1:1	985-1	Single Action Gun	1000 lb _f	186 psi
2:1	985-3	Single Action Gun	1000 lb _f	247 psi

Cordless Guns Designed to use a DL-24-T19E drive system and a B26T600XL. Included with each gun is (1) 982-2 18 volt Lithium-ion battery and (1) 982-3 charger; components can be purchased separately or as follows:

1:1	934-1E	Cordless Gun	900 lb _f	167 psi
2:1	934-2E	Cordless Gun	900 lb _f	222 psi

Albion ENGINEERING Tidbit™

Cordless Guns— State-of-the-Art Performance, Portability, and Control.

- **Heavy Duty**— all-metal gear box develops 620 lbs force; composite carriage strongest in the industry.
- **High Productivity**— max speed of 23 inches per minute gets the job done faster; double the power of most manual guns.
- **Ergonomic**— design greatly reduces trigger-hand fatigue and wrist strain.
- **Total Dispensing Control**— set speed rate and fine tune with variable speed trigger.
- **Power Efficient**— dispense over 185 latex 10 oz cartridges or over 60 cold urethane 10 oz cartridges on one charge.
- **Auto-reverse**— relieves pressure and reduces cartridge run-on.



variable speed trigger

speed dial

MULTI-COMPONENT

MULTI-COMPONENT GUNS

1200 Series Cartridge Specifications

Unique characteristics of the cartridges in this category:

- Either a 2 Piece snap-together or a molded one piece cartridge
- Designed to easily slide into a dispensing tool and to be held rigidly
- Multiple ratios fit one dispensing tool with no alterations to the tool
- Require “bell” shape mixer with locking nut. (544-7)

1200 Series Cartridges: Compact package designed to contain multi-ratio products. The total cartridge length is 8¹/₂ inches

Note: the 3/4 view below is an example, but not exclusively a representation of the cartridge face

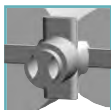

Cartridge Ratio:	1:1	2:1	4:1	6:1	20:1
Volume (ml):	600x600ml (44oz)	600x300ml (30.5oz)	600x150ml (27.5oz)	600x100ml (25.5oz)	600x30ml (11oz)
Outside Diameters (in.):	2 ¹³ / ₁₆ x 2 ¹³ / ₁₆	2 ¹³ / ₁₆ x 2	2 ¹³ / ₁₆ x 1 ¹⁵ / ₃₂	2 ¹³ / ₁₆ x 1 ¹ / ₄	2 ¹³ / ₁₆ x 3 ³ / ₄



Connecting Nut & Static Mixer: see p. 64 for assorted Static Mixer nozzles

MULTI-COMPONENT

Albion ENGINEERING Tidbit™

LADDER HOOK PULLS—

Albion Bulk, Sausage, and Cartridge guns accept Ladder Hook Pulls that conveniently hang for ready use. Simply screw on to the piston rod of any Albion model.



Aluminum: 310-1

Steel: 416-G01

Steel: 310-2



MULTI-COMPONENT GUNS

1200 Series



The Professional's Preferred Choice

Ratio	Model	Description	Thrust	Pressure ⁺
-------	-------	-------------	--------	-----------------------

Core Tools

These Albion guns are commonly used by the serious professional for two component applications

1200 Series

1:1	946-1U	Ultra Manual Gun	1100 lb _f	102 psi
2:1			1100 lb _f	136 psi
4:1			1100 lb _f	163 psi
6:1			1100 lb _f	174 psi
1:1	AT900	Standard Configuration	1250 lb _f	100 psi
2:1			1250 lb _f	100 psi
1:1	AT900-S	Suitcase Configuration	1250 lb _f	100 psi
2:1			1250 lb _f	100 psi

1200 SERIES VARIATIONS: Tools built for unique situations

* B-Line

Ratio	Model	Description	Thrust	Pressure
-------	-------	-------------	--------	----------

B26T600



1200 B-Line Variations

Incorporating USA engineered technology with the savings of an import; guns feature full carriage containment units

1200 Series Cartridges:

1:1	B26T1200	Manual Gun (26:1 Drive)	900 lb _f	83 psi
2:1	B26T900	Manual Gun (26:1 Drive)	900 lb _f	111 psi
4:1	B26T750	Manual Gun (26:1 Drive)	900 lb _f	133 psi
6:1	B26T700	Manual Gun (26:1 Drive)	900 lb _f	142 psi

MULTI-COMPONENT

Albion Engineering Co. 856-235-6688 www.albioneng.com

(pressure [psi] is what moves material out of the nozzle; higher number = higher pressure)

MULTI-COMPONENT GUNS

1500 Series Cartridge Specifications

Unique characteristics of the cartridges in this category:

- Either a 2 Piece snap-together or a molded one piece cartridge
- Designed to easily slide into a dispensing tool and to be held rigidly
- Multiple ratio fit one dispensing tool with no alterations to the tool
- Require “bell” shape mixer with locking nut (544-7)

1500 Series Cartridges: Compact package designed to contain multi ratio products; the total cartridge length is 8¹/₂ inches; (Most common tool used is the B26T1500X)

Note: the 3/4 view below is an example, but not exclusively a representation of the cartridge face

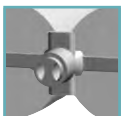

Cartridge Ratio:	1:1	1.25:1	2.5:1	5:1	10:1
Volume (ml):	750x750ml (51oz)	750x600ml (42oz)	750x300ml (35.5oz)	750x150ml (30.5oz)	750x75ml (26oz)
Outside Diameters (in.):	3 ¹ / ₈ x 3 ¹ / ₈	3 ¹ / ₈ x 2 ¹³ / ₁₆	3 ¹ / ₈ x 2	3 ¹ / ₈ x 1 ¹⁵ / ₃₂	3 ¹ / ₈ x 3 ¹ / ₁₆
Cartridge Part Number:					
Cartridge "A"	741-G01	N/A	741-G01	741-G01	741-G01
Cartridge "B"	741-G01	N/A	741-G02	741-G03	741-G05



Connecting Nut & Static Mixer: see p. 64 for assorted Static Mixer nozzles

MULTI-COMPONENT GUNS

1500 Series

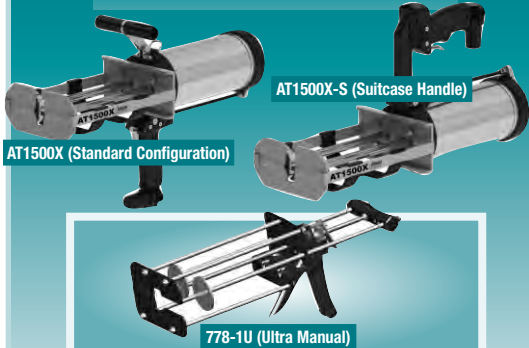

The Professional's Preferred Choice

Ratio Model Description Thrust Pressure⁺

Core Tools

These Albion guns are commonly used by the serious professional for two component applications

1500 Series

1:1	778-1U	Ultra Manual Gun	1100 lb _f	81 psi
2.5:1			1100 lb _f	116 psi
5:1			900 lb _f	135 psi
10:1			900 lb _f	147 psi
1:1	AT1500X	Standard Configuration	1500 lb _f	120 psi
1:1	AT1500X-S	Suitcase Configuration	1500 lb _f	120 psi
10:1	AT825	Standard Configuration	1250 lb _f	100 psi
10:1	AT825-S	Suitcase Configuration	1250 lb _f	100 psi

1500 SERIES VARIATIONS: Tools built for unique situations

* Ratio Set-ups * B-Line * Thrust * Special Applications

Ratio Model Description Thrust Pressure

778-2U



1500 Radio Set-up Variations

The standard 778-1U is available in various cartridge ratio setups

1:1	778-2U	Ultra Manual Gun (comes setup 2.5:1)	1100 lb _f	81 psi
2.5:1			1100 lb _f	16 psi*
5:1			1100 lb _f	135 psi
10:1			1100 lb _f	147 psi
1:1	778-3U	Ultra Manual Gun (comes setup 5:1)	1100 lb _f	135 psi
2.5:1			1100 lb _f	81 psi
5:1			1100 lb _f	116 psi
10:1			1100 lb _f	147 psi
1:1	778-4U	Ultra Manual Gun (comes setup 10:1)	1100 lb _f	147 psi
2.5:1			1100 lb _f	81 psi
5:1			1100 lb _f	116 psi
10:1			1100 lb _f	135 psi

MULTI-COMPONENT

Albion Engineering Co. 856-235-6688 www.albioneng.com

(pressure [psi] is what moves material out of the nozzle; higher number = higher pressure)

MULTI-COMPONENT GUNS & VARIATIONS

1500 SERIES VARIATIONS: Tools built for unique situations

* Ratio Set-ups * B-Line * Thrust * Special Applications

Ratio Model Description Thrust Pressure

B26T905



1500 B-Line Variations

Incorporating USA engineered technology with the savings of an import; guns feature full carriage containment units

1500 Series Cartridges:

1:1	B26T1500X	Manual Gun (26:1 Drive)	900 lb _f	66 psi
5:1	B26T905	Manual Gun (26:1 Drive)	900 lb _f	110 psi
10:1	B26T825	Manual Gun (26:1 Drive)	900 lb _f	120 psi

1500 Special Applications Variations



Extension Guns: Crack guide pin to improve control & with adjustable wheel assembly for comfortable upright dispensing; excellent for traffic detector inductance loops, pavement expansion joints, and roof membrane lap joints

Manual Guns

1:1	B26T1500XL	Manual Extension Gun	900 lb _f	66 psi
-----	------------	----------------------	---------------------	--------

Air-Powered Guns Designed to use a 200-7 air drive system and a B26T1500XL; components can be purchased separately or as follows:

1:1	967-1	Single Action Gun	1,070 lb _f	78 psi
-----	-------	-------------------	-----------------------	--------

Cordless Guns Designed to use a DL-24-T19E drive system and a B26T1500XL; included with each gun is (1) 982-2 18 volt Lithium-ion battery and (1) 982-3 charger; components can be purchased separately or as follows:

1:1	930-1E	Extension Cordless Gun	900 lb _f	66 psi
-----	--------	------------------------	---------------------	--------

MULTI-COMPONENT

Round Static Mixers:

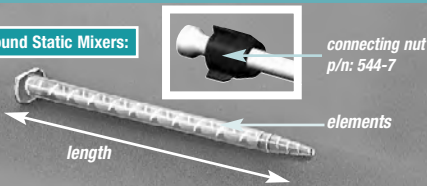

Part Number:	Diameter:	Elements:	Length:
484-160-632	1/4"	32	9 1/2"
484-160-624	1/4"	24	7 1/2"
484-160-824	3/8"	24	9 3/8"
484-160-818	3/8"	18	7 3/8"
484-260-812	3/8"	12	5 1/8"
484-161-230	1/2"	30	14 1/8"
484-161-224	1/2"	24	7 1/2"
484-160-815	3/8"	15	11 5/8"
484-161-218	1/2"	18	9 5/8"

MULTI-COMPONENT GUNS

380ml Co-Axial Cartridge Specifications

380ml Co-Axial Series (14oz): Compact package, designed to contain a combined total of 380ml, or 14oz ounces, of material; commonly sold in Europe with limited exposure in the USA; the most popular unit is a 10:1 ratio cartridge, 7¹/₄ inches long with an outside diameter of 2¹/₂ inches



Note: the view (left) is an example, but not exclusively a representation of the cartridge face



380ml Co-Axial



The Professional's Preferred Choice

Ratio	Model*	Description	Thrust	Pressure
-------	--------	-------------	--------	----------

Core Tools

These Albion guns are commonly used by the serious professional for two component applications

380ml Series Manual Cartridges

10:1	B26C380	Manual Gun	900 lb _f	223 psi
------	----------------	-------------------	---------------------	---------

380ml Series Cordless Cartridges

10:1	947-1E	Cordless Gun	925 lb _f	155 psi
------	--------	---------------------	---------------------	---------

Albion ENGINEERING Tidbit™

Engineering History—

Albion was founded in 1929 by F. Karl Schneider and in 1935 he patented the first Smooth Rod Drive Caulking Gun; for three generations Albion has been in the forefront of engineering, innovation, and design excellence
 Patent No. 1986166

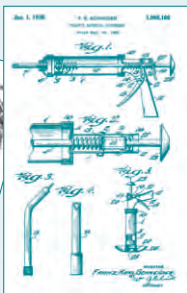

MULTI-COMPONENT

MULTI-COMPONENT GUNS

AT 1200S Series Specifications

Twin Sausage Cartridges



AT1200S (Suitcase Handle)

The Professional's Preferred Choice

Ratio	Model	Description	Thrust	Pressure
-------	-------	-------------	--------	----------

Core Tools

These Albion guns are commonly used by the serious professional for two component applications

1:1	AT1200S	Suitcase Configuration <ul style="list-style-type: none"> For 2-component 20oz sausage packs Ergonomic Suitcase handle Improved manifold and 4" air cylinder make for the fastest dispensing tool in its category 	1,900 lb _f	470 psi
-----	---------	---	-----------------------	---------

Unique characteristics of the sausage in this category:

- Ergonomic design
- Faster flow increases productivity
- Responsive and easy reload
- Rugged construction

AT1200S Series Sausages: *Designed to reduce waste; fixed 1:1 material ratio; fits a 2 inch diameter barrel; requires static mixer*

20oz/20oz Sausage Cartridges: *Unique characteristics of the sausages in this category:*

- Designed to reduce waste with a fixed 1:1 ratio.
- Sausage fits in a 2 inch diameter x 12.5 inch long barrel.
- Requires Static Mixer (see below)

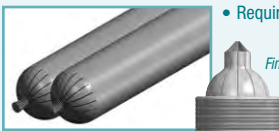

Final sausage shape after use.

MULTI-COMPONENT GUNS & VARIATIONS

20oz/20oz Sausage & Static Mixers

Static Mixers/Manifold:

- Designed specific to materials packaged in sausage packs

Pipe Style Static Mixers:

Designed exclusively for 635-1 and AT1200-S Twin models. *Disposable*

Plastic type: connects directly to the manifold outlet; it has a built in 3/4 inch NPT threaded coupling, eliminating the need for separate connecting nut

Reusable Stainless Steel model: includes three 8-element plastic mixer sticks



645-G05 Manifold for All Tools

- Machined from a single block of aluminum
- Provides optimum flow of material
- Includes two replaceable viton o-rings (192-6)

TWIN SAUSAGE VARIATIONS: Tools built for unique situations

* Thrust * Special Applications

Ratio	Model	Description	Thrust	Pressure
-------	-------	-------------	--------	----------

AT1200S-2



1200S Variation

Incorporating USA engineered technology with the savings of an import; guns feature full carriage containment units

- | | | | | |
|-----|-----------|--|----------------------|---------|
| 1:1 | AT1200S-2 | Standard Configuration) | 1900 lb _f | 470 psi |
| | | • For highway and parking structure joint sealant installation | | |
| | | • 2-Hand Dispensing Tool | | |

The New Generation AT1200S will replace the 635-1 (20oz/20oz) Twin Sausage Cartridge Guns and 670-2 Carts

Double Action Gun: Commonly used in industrial or underwater applications; Shown with optional Collapsible Cart (670-2) and Static Mixer

- | | | | |
|-------|-----------------------------------|-------------------|---------|
| 635-1 | Original Tool | 1500 _f | 370 psi |
| 670-2 | Collapsible Cart shown with 635-1 | | |

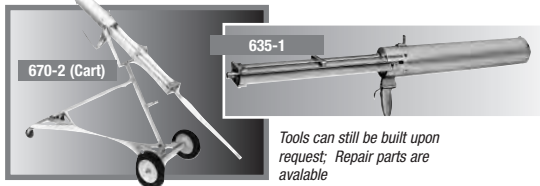

Tools can still be built upon request; Repair parts are available

MULTI-COMPONENT

GUN ACCESSORIES

STANDARD APPLICATIONS— Metal Caps & Nozzles

Standard Applications—Front Caps for Metal Nozzles

Standard Albion Metal Front Cap:

- Fits all “Albion” standard size Bulk and Sausage guns
- Standard 3/8” NPS Thread— accepts most standard metal nozzles

P/N:	Description:
26-6	2” Clip Cap
426-G01	2” Threaded
26-28	2” Threaded**
220-G01	2 5/8” Threaded***

Front Cap

426-G01



** Used with Cartridge Air Gun only *** 770 Series Guns

Metal Jumbo Cap:

- 7/8” -20 NEF Thread; used with Jumbo nozzles

P/N:	Description:
26-25-2	2” Clip Cap
426-G25	2” Threaded
220-G03	2 5/8” Threaded***
221-G01	3 3/8” Threaded****

Jumbo Cap

426-G25



*** 770 Guns ****103 and 200 Series Guns

Flat Caps: (p/n 421-G05)

- Used on full barrel cartridge guns to accept Albion metal nozzles
- Used with DL-24 or DL-810 series guns

421-G05



Standard Applications— Metal Nozzles

- Excellent wear resistance when working on masonry & other abrasive surfaces
- Fits Albion standard bulk/sausage front cap (p/n 426-G01)

Round Nozzles

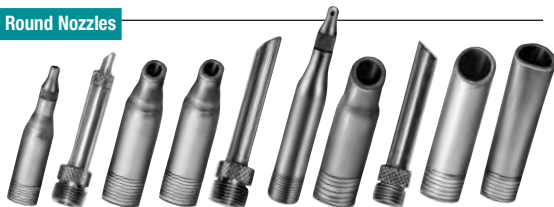

32-22 32-46 32-49 32-33 32-47 32-37 32-88 32-48 32-55 32-77

Standard Round Nozzles: provide a round bead of sealant or adhesive; commonly used to fill joints or apply adhesive to surfaces



32-33

Style “A”:

One piece formed construction

P/N	Bead Diameter
32-22	1/8”
32-49	3/16”
32-33	1/4”
32-88	3/8”
32-55	1/2”
32-77	5/8”
32-35****	3/4”

(****Jumbo nozzle fits a jumbo front cap (P/N 426-G25)



32-47

Style “B”:

Two or three piece construction

P/N	Bead Diameter
32-46	1/8”
32-47	1/4”
32-48	3/8”
32-37	3/32” Grouting

GUN ACCESSORIES

STANDARD BULK/SAUSAGE & B-LINE— Plastic Nozzles

Overview: Plastic Nozzles

- Easily cut to size for the application with a utility knife
- Generally used for a few applications and discarded

Standard Applications—Front Caps for Plastic Nozzles

Ring Cap: (p/n 421-G01)

- Used with the (p/n 235-3 & 935-3) Cone Nozzles or (p/n 587-2) Cap Insert



P/N:	Description:
163-G02	2" Clip Cap Barrel
421-G01	2" Threaded Barrel
2-G16	2" Threaded Barrel**

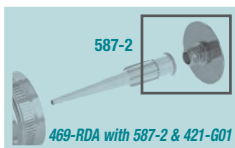

** used with Cartridge Air Gun only

Plastic Nozzles—Albion Line

Albion Orange Cone Nozzle: (p/n 235-3)

- Fits all Albion standard Bulk/Sausage Guns with a ring cap (p/n 421-G01)
- 4.5" long

Bent Cone Nozzle: (p/n 935-3)

- 45 degree bend for better control
- Used with 421-G01 ring cap
- 6.5" long



Plastic Nozzles: B-Line

Standard B-Line Plastic Front Cap: (p/n 873-5)

- Fits B-Line Bulk and Sausage Guns
- Retains 873-2 Nozzle or 873-3 Black Cone Nozzle and 935-4

Front Cap



B-Line Clear Narrow Nozzle: (p/n 873-2)

- Fits B-Line Bulk/Sausage Guns with ring cap 873-5 to B-Line Bulk and Sausage Guns
- 4.5" long

B-Line Black Cone Nozzle: (p/n 873-3)

- Fits B-Line Bulk/sausage guns with a ring cap (p/n 873-5)
- Purchased in 10 unit packs
- 4.5" long



935-4

Bent Cone



B-Line 45 Degree Bent Cone Nozzle: (p/n 935-4)

- 45 degree bend for better control & fits all B-Line Bulk/sausage guns with a ring cap (p/n 873-5)
- 6.5" long

Cap Adapters: (p/n 811-1)

- To adapt (p/n 873-5) black plastic B-Line cap to Albion standard 2 inch threaded steel or aluminum barrels

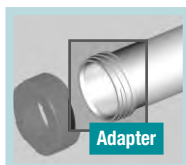

ACCESSORIES

GUN ACCESSORIES

CARTRIDGE NOZZLES

Plastic Cartridge Nozzles

Angle Shot Green Plastic Nozzle: (p/n 935-1)

- Slips over 1/10 gallon standard cartridge nozzle
- 45 degree bend for better access
- 7" long

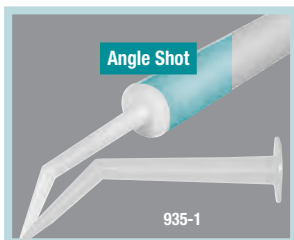

Narrow Nozzle: (p/n 769-4-RDA)

- Easily sized for the application & generally used for a few applications and discarded
- Fits Albion standard bulk/ sausage guns with a ring cap (P/N 421-G01) and Metal Ring Cap Insert (p/n 587-2)

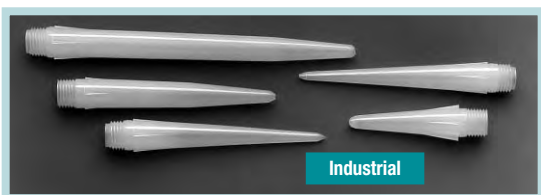

Industrial Plastic Nozzles:

- Fits industrial style "SEMCO" cartridge (see catalog 259A)
- 1/4 NPS thread; standard Albion cap requires 27-2 Adapter

P/N:	Tip Diameter:	Tip Length:
383-410	1/32"	4"
383-252	1/16"	2"
383-420	1/16"	4"
383-430	3/32"	4"
383-540	1/8"	2 1/2"
383-640	1/8"	6"
383-1004	1/8"	10"

SPECIAL APPLICATIONS— Metal Nozzles

Metal Nozzles

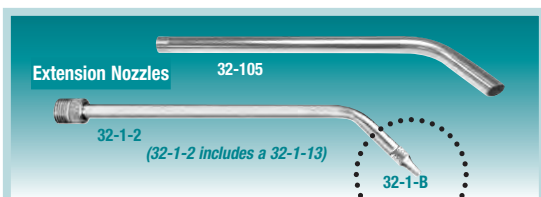

- Fit 426-G01 standard Albion metal front cap
- Improves ability to reach difficult applications like applying sealant around circular structures (pipes, conduit, etc.)
- One piece formed construction with 1/2" bead diameter or three piece construction with 1/8" or 1/4" bead diameter
- Consider using a high thrust gun with extension nozzles

GUN ACCESSORIES

SPECIAL APPLICATIONS— Metal Nozzles

Metal Nozzles— Bendable

Aluminum Bending Nozzles:

- Allows you to reach difficult locations

P/N:	Bead Shape:
32-112	3/8" x 12" length
32-113	3/8" x 18" length
32-114	3/8" x 24" length

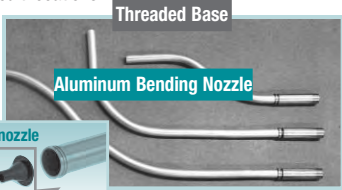

Optional: 966-2 with 32-112 nozzle



Required for B-line use

- Threaded base style bendable nozzles fit 426-G01 front cap
- To use with 421-G01 front cap add 966-1 adapter
- To use with B-Line front cap 873-5 add 966-2 adapter

P/N:	Bead Shape:
32-116	1/2" x 12" length
32-117	1/2" x 18" length
32-118	1/2" x 24" length

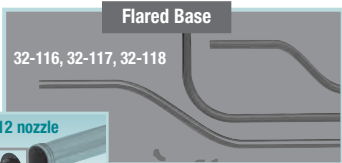

Required: 970-g02 with 32-112 nozzle

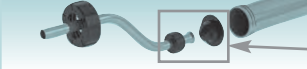

Required for Flared Nozzle

- Fits "Albion" standard bulk and sausage guns with 421-G01 front cap and 970-G01 adapter
- Fits 873-5 B-Line front cap with 970-G02 adapter

Metal Nozzle Extenders:

- For hard to reach applications
- Available in 3, 6, 12 & 18" increments

Note: the longer the nozzle the harder it will be to push material through the nozzle; consider upgrading to a high thrust gun

P/N:	Extension Length:
248-G03	3"
248-G06	6"
248-G12	12"
248-G18	18"



SPECIAL APPLICATIONS— Metal Caps & Nozzles

Special Applications: Metal Caps & Nozzles

Ribbon Bead Metal Nozzles:

- Provides ribbon or flat 1/8" high beads of adhesive or sealant

P/N:	Bead Shape:	P/N:	Bead Shape:
32-45	1/8" x 3/8"	32-17	1/8" x 3/4"
32-1313	1/8" x 9/16"		



ACCESSORIES

GUN ACCESSORIES

SPECIAL APPLICATIONS— Metal Caps & Nozzles

Special Applications: Metal Caps & Nozzles

Ribbon Bead Caps:

- Provides ribbon or flat beads of adhesion or sealant

P/N	Bead Size	Description
32-14-3	1/8" x 1"	2" Clip Cap
32-14-5	1/8" x 1"	2" Threaded
32-10-5	1/8" x 2 1/2"	2" Threaded
32-10-9	1/8" x 2 1/2"	2 5/8" Threaded***
*** 770 Series Guns		
32-102-G01	1/4" x 3"	2" Threaded
32-103-G01	1/4" x 3 1/2"	2" Threaded



Narrow Joint Nozzles:

- To ensure material gets to bottom of a narrow joint

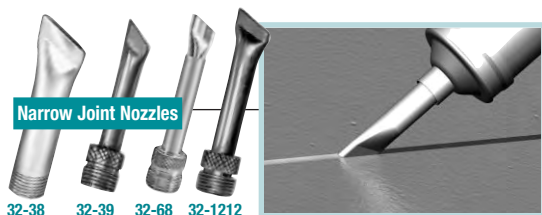

P/N:	Nozzle Opening:	P/N:	Nozzle Opening:
32-68	3/64" x 7/16"	32-38	1/8" x 7/8"
32-1212	1/16" x 1 1/16"	32-101	1/8" x 1 1/2"****
32-39	3/32" x 7/16"		

**** Jumbo nozzle fits a jumbo front cap (p/n 426-G25)

Narrow Joint Cap:

- For unique applications

P/N	Bead Size	Description
32-16-3	1/8" x 1 1/2"	2" Clip Cap
32-16-5	1/8" x 1 1/2"	2" Threaded



Self-Threading Nozzle: (p/n 732-1)

- Cuts its own thread on plastic quart cartridge nozzles

732-1



Special Applications: Metal Caps & Nozzles

Jumbo Nozzles:

- With 7/8" 20 NEF thread (fits 426-G25 front cap)

P/N:	Bead Diameter:
32-35	3/4"
32-40	5/8"
32-101	1/8" x 1 1/2"



GUN ACCESSORIES

SPECIAL APPLICATIONS— Metal Caps & Nozzles

Special Applications: Metal Caps & Nozzles

Fillet Metal Nozzles:

P/N:	Triangle Sides:
32-44	3/8"
32-66	7/16"
32-100	9/16"



Fillet Nozzles

32-44 32-66 32-100

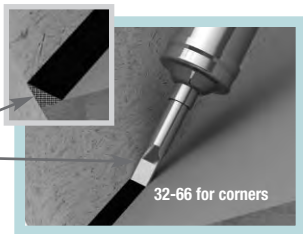

32-66 for corners

Double Bead Nozzle



32-110

Double Bead Cap



26-26

Double Bead Caps:

- Accepts Albion metal nozzles on 1 inch centers
(p/n 26-26)

Double Bead Nozzle:

- Saves time and increases precision when installing silicone tape profiles

P/N:	Nozzle Opening:	P/N:	Nozzle Opening:
32-109-5	3/8" dia x .5" center	32-111-5	3/8" dia x 1.5" center
32-110-5	3/8" x 1" center	32-115-5	3/8" dia x 2" center

Check Valve Nozzle:

- Dispenses small dab of sealant per activation (p/n 903-1)
- For sealing screw heads on metal roofing



Check Valve Nozzle

903-1

Precision Metering Metal Nozzle:

- Provides a precision ribbon bead
- Commonly used on lap joints or membrane roofing

P/N:	Bead Shape:
446-G05	Triangular 1/4" high x 1 ¹³ / ₁₆ " wide
446-G06	Custom Shape**

** Adjustable blade can be cut to a custom shape. Max size high by 1¹/₄" wide. Additional blades (p/n 446-H07)

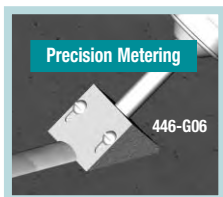

Precision Metering

446-G06

ACCESSORIES

GUN ACCESSORIES

SPECIAL APPLICATIONS— Moldings, Ports, Reducers & Couplings

Special Applications: Cove Base Molding

Cove Base Molding Cap or Nozzle:



P/N	Molding	Bead Details (all dispense 3/16" beads on 1" centers)
32-63	2 1/2"	Two Beads, Jumbo Nozzle
	2 1/2"	Two Beads, Premium Cap
32-59-G05		fits 2" Threaded Barrel
32-59-G09		fits 2 5/8" Threaded Barrel***
32-59-G08		fits 3 3/8" Threaded Barrel****
	4"	Three Beads, Standard Cap
32-41-5		fits 2" Threaded Barrel
32-41-9		fits 2 5/8" Threaded Barrel***
	4"	Three Beads, Premium Cap
32-60-G05		fits 2" Threaded Barrel
32-60-G09		fits 2 5/8" Threaded Barrel***
32-60-G08		fits 3 3/8" Threaded Barrel****
32-65	6"	Five Beads, Jumbo Nozzle
	6"	Five Beads, Premium Cap
32-56-G05		fits 2" Threaded Barrel
32-56-G09		fits 2 5/8" Threaded Barrel***
32-56-G08		fits 3 3/8" Threaded Barrel****

*** 770 Guns **** 103 and 200 Series Guns

Standard Applications: Ports & Nozzles

Plastic Injection Ports:

- Use with Metal Nozzles
- 32-32, 32-46, 32-11-2, 32-1-2

P/N:	Description:
772-4	3/4" round
772-3	surface mount

Injection Port Coupling:

- Easy to connect and disconnect to 1/8" tube injection ports***

P/N:	Description:
791-3	standard 2" Bulk Gun (426-G01) to port

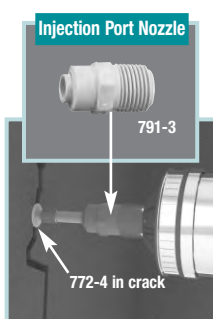
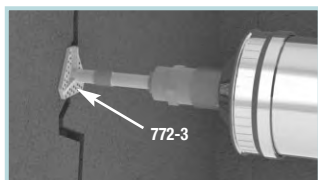
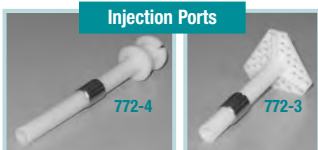

ACCESSORIES

GUN ACCESSORIES

SPECIAL APPLICATIONS— Moldings, Ports, Reducers & Couplings

Standard Applications: Reducers & Adapters

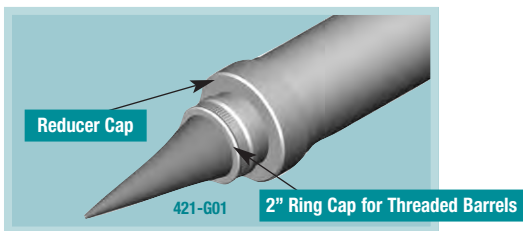

Cap Reducers:

- Adapts large diameter barrels to standard 2" Threaded Caps and Nozzles

<u>P/N:</u>	<u>Barrel Diameter Gun:</u>	<u>P/N:</u>	<u>Barrel Diameter Gun:</u>
187-G05	3 ³ / ₈ " **** ****103 and 200 Series Guns	297-G05	2 ⁵ / ₈ "**** ***770 Guns

Thread Reducers

Thread Reducer



Couplings



Reducers:

- Connect nozzles to caps, cartridges or extensions

<u>P/N:</u>	<u>Threads:</u>		<u>Use</u>
	<u>External</u>	<u>Internal</u>	
27-1	1/4 NPS	1/8 NPS	to Adapt Metal Nozzles to the Industrial Cartridges (383 Series)
27-2	3/8 NPS	1/4 NPS	to Adapt Plastic Industrial Nozzles to Albion Standard 421-G01 Cap
27-7	3/8 NPS	1/8 NPS	to Adapt Small Metal Nozzles to Albion Standard Bulk/Sausage Guns
27-6	7/8-20	3/8 NPS	to Adapt Standard Metal Nozzles to Albion Jumbo Caps
171-1	3/8 NPS	9/16 NPS	to Adapt a Nozzle with 3/8 NPS Threading to a Cap with 9/16 NEF
171-2	3/8 NPS	3/8 NPS	Couple a 3/8 NPS Threaded Nozzle to a 3/8 NPS Threaded Front Cap or a Nozzle Extension
171-3	3/8 NPS	5/8 NC	Threaded Nozzle Coupling 3/8 NPS to 5/8 NC

GUN ACCESSORIES

CARTRIDGES & NOZZLES

10oz Single Component Cartridges:

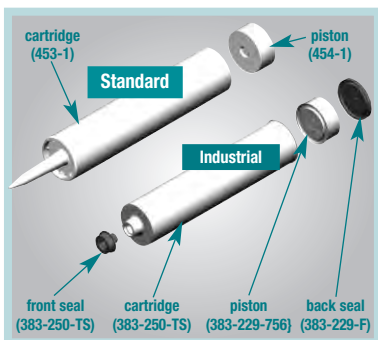

Features:

- Fits most standard 10oz (1/10 Gallon) Cartridge Guns
- General purpose applications
- High density polyethylene plastic
- When loading use Albion's "Caulking Loader" and Adaptor (p/n 343-H357)
- Standard Cartridge (p/n 453-1)
- Standard piston (p/n 454-1)
- Industrial Style Cartridge: Excellent selection of nozzles for precise, accurate applications (see page70)

Single Component Industrial Cartridges:

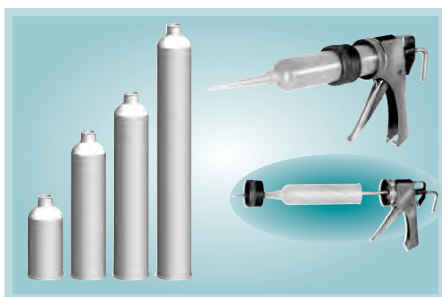

Features:

- Generally used for adhesive applications
- Unique cartridge design requiring cartridge specific tools
- Common in automatic, semi-automatic, and manually applied processes.
- Excellent selection of nozzles for precise, accurate applications. See Metal and Plastic Nozzles (page 70)
- When loading use Albion's Caulking Loader and 343-H361 Adaptor
- Includes piston and plug

P/N:	Cartridge Length:	Ounces:
383-250-C2 ^{1/2}	1 ^{5/8} x 2 ^{1/2}	2.5oz
383-250-C6	1 ^{5/8} x 6	6oz
383-250-C8	1 ^{5/8} x 8	8oz
383-250-C12	1 ^{5/8} x 12	12oz

GUN ACCESSORIES

GUN MODIFIERS

Leather Pistons:

Standard Leather Piston Packing Replacements: recommended for general purpose applications. Improves dispensing performance. Flexible, long-lasting and durable. To customize your tools for specific types of adhesives and sealants see SYNTHETIC UPGRADES on page 79.

Application: Standard leather pistons for most applications.

- Toughest, easily handles harsh abrasives such as grout.
- Best all-around chemical resistance.

Required Maintenance:

- Leathers must be soaked in light weight oil between cleanings to retain their sealing properties.

P/N	Diameter	Load
21-1	2"	Bulk
21-8	2 ⁵ / ₈ "	Bulk
21-4	3 ³ / ₈ "	Bulk



Kits 47-7 (2"); 47-8 (2⁵/₈"); 47-9 (3³/₈")



Kits 47-1



Standard Piston Replacement Kits: replaces worn-out parts.

P/N	Diameter	Style
Deluxe Drive:		
47-1	2"	Bulk
47-10	2"	Special Applications
Special Deluxe Drive:		
47-7	2"	Bulk
47-8	2 ⁵ / ₈ "	Bulk
47-9	3 ³ / ₈ "	Bulk
47-13	2"	with Expander
47-42	2"	Bulk/Sausage - Teflon®
47-23	2"	Sausage - Polyfinger
Air-Powered Drive:		
47-47	2"	Sausage
47-48	2"	Bulk
47-49	2"	Sausage
B-Line:		
873-22	2"	Sausage

GUN ACCESSORIES

GUN MODIFIERS

Expanders:

Piston Cup: The most economical way to reduce blow-by. Pushes uniformly on the edge of the leather piston resulting in cleaner wipe of barrel wall.

P/N	Diameter	Description
222-2	2"	Finger-type Expander
212-165	2"	"C" Expanders
212-287	3 $\frac{3}{8}$ "	"C" Expanders



Adjustable Wedge-Type: Mechanical way to ensure the best seal. Adjust it and lock it. Prolongs life of piston.

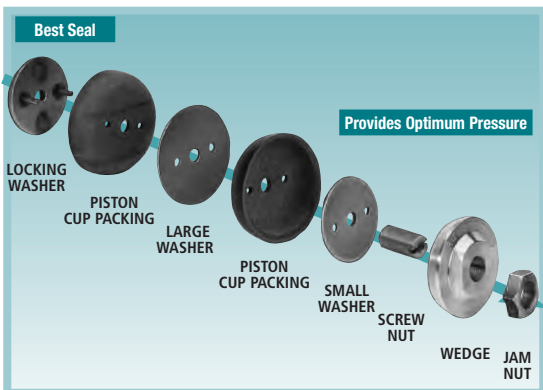

P/N	Description
47-35	2" LEATHER cups for 5/16" square rod used in Special Deluxe models.
47-36	2" TEFLON ® cups for 5/16" square rod used in Special Deluxe models.
47-37	2" LEATHER cups for 1/4" square rod used in Deluxe models.
47-38	2" TEFLON ® cups for 1/4" square rod used in Deluxe models.
47-46	2 $\frac{5}{8}$ " LEATHER cups for 5/16" square rod used in Special Deluxe models.
47-45	3 $\frac{3}{8}$ " LEATHER cups for 5/16" square rod used in Special Deluxe models.

GUN ACCESSORIES

GUN MODIFIERS

Piston Packing Replacements:

Synthetic Upgrades for Special Applications: Optimizes your piston assembly for various types of adhesives and sealants. Improves dispensing performance. Albion's twin single-cup system allows individual piston cup replacement. All Albion Bulk models come equipped with standard 21-1 Soft Leather Piston Cups for general purpose applications.

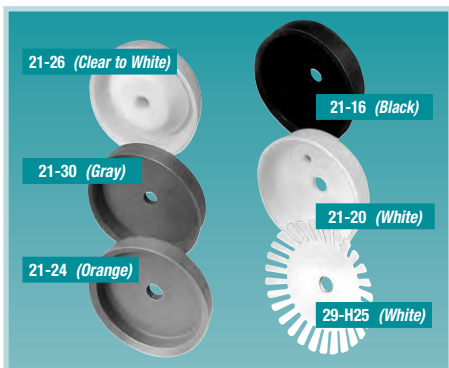

<u>P/N</u>	<u>Diameter</u>	<u>Piston Cup Type</u>	<u>Load</u>
21-7	2"	Impregnated Leather	Bulk
Stiffer than Standard 21-1 leather. Recommended with 222-2 Piston Expander. Requires less maintenance.			
21-16	2"	Nitrile Rubber	Bulk
Use only when chemicals and harsh cleaning agents are not a factor. Recommended for bulk applications with water based materials. Easy to clean. Good air-gun seal.			
21-20	2"	TEFLON®	Bulk/Sausage
Most chemically-resistant synthetic piston available. Higher in cost, easily damaged if abused. Universal piston for bulk and sausage applications.			
29-H25*	2"	Polyethylene	Sausage
Polyfinger design. Disposable sausage piston. Lower cost alternative when reliability is important. For best results use and replace after a few days work.			
21-30	2"	Poly Plastic	Bulk
Low cost bulk alternative.			
21-24	2"	Hytrel	Bulk/Sausage
Stiff piston, designed to scrape material from barrel walls. Good chemical resistance. Recommended for bulk and sausage applications.			
21-26	2"	Nylon	Bulk/Sausage
Same stiffness as Hytrel, but with better chemical resistance. Recommended for bulk and sausage applications.			
873-6	2"	Plastic	Sausage
For B-Line and AT1200S Sausage guns			
873-35	2"	Hytrel	Bulk
Occasional use; Bulk piston for B-Line Sausage guns			

GUN ACCESSORIES

GUN MODIFIERS

Replacement Pulls:

Standard T-Pull

Replacements:

Aluminum cast T-Pull.
Standard
on Twin-Component
Special Deluxe drives.

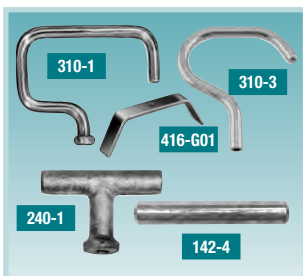

P/N

240-1

Description

Aluminum Cast

T-Pull. Standard on Twin-Component Special Deluxe drives.

142-4

Steel T-Pull. Standard on all Single-Component Special Deluxe drives.

Replacement Rod and Racks:

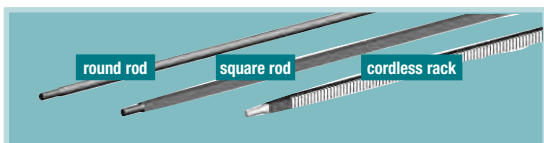

P/N

Description

Special Deluxe Manual Guns:

255-23	DL-24 Series
255-1	DL-45 Series
255-3	DL-45 Sausage Guns with Teflon Piston & 770 Series
255-5	DL-59 Series, 103 Series
255-33	DL-79 Series
255-28	846 Series
255-10	380 & 139 Series

Deluxe Manual Guns:

273-6	DL-24 Series
273-5	DL-32 Series
273-3	DL-45 Series
273-18	Quart Cartridge Guns

Ultra Manual Guns:

819-14	DL-24 Series
819-6	DL-45 Bulk and Sausage Guns
819-2	DL-59 Series, 103 Series
819-9	846 Series

Air Guns:

190-H19	DL-24 Series
190-H06	DL-45 Series
190-H07	DL-59 Series, 103 Series

Cordless Guns: Lithium-ion Series

993-G03	DL-24 Series
993-G02	DL-45 Series & 770 Series
993-G01	SDL-59 Series, 103 Series
993-G04	846 Series
993-G05	405-15E
993-G13	DL-32 Series
993-G10	DL-79 Series

GUN ACCESSORIES

BULK LOADING ACCESSORIES

Overview: Bulk Loading Accessories

Loading a bulk gun can be difficult and messy; the following items improve productivity and reduce mess

- 1. Loading Sleeve**— designed to keep the material off the outside of the barrel by sliding over the barrel when loading
- 2. Follow Plate**— designed to minimize the material's exposure to air and improve the loading process; specific technique or familiarity required to successfully use this accessory
- 3. Caulking Loader**— designed to mechanically load material in a tool both quickly and easily; loaders are designed to fit specific pails; read the information below before selecting the correct loader

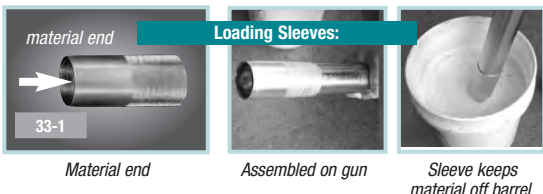

- For 2 inch diameter models only; slips over and locks on to the gun barrel to keep end free of material

P/N:	Description:	P/N:	Description:
33-1	Threaded Barrel Guns	33-3	Clip Cap Barrel Guns

Straight & Tapered Pails, Follow Plates

Follow Plates:

- Designed to fit inside pail; more specific requirements below

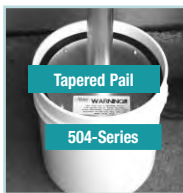

Straight Metal Pails:

P/N	Description	Pail- Inside Diameter
117-12	2 Gallon for Threaded Barrel Gun	6 ⁷ / ₁₆ "
117-13	2 Gallon for Clip Cap Barrel Gun	6 ⁷ / ₁₆ "
117-14	5 Gallon for Threaded Barrel Gun	8 ³ / ₈ "
117-15	5 Gallon for Clip Cap Barrel Gun	8 ³ / ₈ "
117-16	5 Gallon for Threaded Barrel Gun	10 ⁷ / ₈ "
117-17	5 Gallon for Clip Cap Barrel Gun	10 ⁷ / ₈ "
345-5	5 Gallon for Threaded Barrel Gun Aluminum Cast w/Neoprene Seal	10 ⁷ / ₈ "

Plastic or Steel Tapered Pails: standard units consist of steel plates and Neoprene rubber seals

P/N	Description	Pail- Inside Diameter	
		(Minimum)	(Maximum)
504-G01	2 Gallon for Threaded Barrel Gun	7 ³ / ₄ "	9"
504-G02	2 Gallon for Clip Cap Barrel Gun	7 ³ / ₄ "	9"
504-G07	5 Gallon for Threaded Barrel Gun	9 ⁷ / ₈ "	11 ³ / ₈ "
504-G08	5 Gallon for Clip Cap Barrel Gun	9 ⁷ / ₈ "	11 ³ / ₈ "
504-G09	504-G01 w/Viton Seal	7 ³ / ₄ "	9"
504-G10	504-G02 w/Viton Seal	7 ³ / ₄ "	9"
504-G11	504-G07 w/Viton Seal	9 ⁷ / ₈ "	11 ³ / ₈ "
504-G12	504-G08 w/Viton Seal	9 ⁷ / ₈ "	11 ³ / ₈ "
504-G13	20 Liter, Threaded	10"	12"

GUN ACCESSORIES

BULK LOADING ACCESSORIES

Caulking Loaders:

- Quick clean method of filling bulk guns and cartridges
- Designed to fit specific pails depending on the pail size and a standard 2-inch diameter threaded barrel gun
- Adaptors available to fit all Albion model dispensing tools/cartridges

Pump Style — Standard Unit:

P/N	Description	Pail- Inside Diameter	
		(Minimum)	(Maximum)
344-7	2 Gallon Pail	7 ³ / ₄ "	9"
344-4	5 Gallon Pail — Straight Side Metal Pail	11 ⁵ / ₁₆ "	
344-4TP	5 Gallon Pail — Metal Tapered Pail	10 ³ / ₄ "	11 ⁵ / ₁₆ "
344-4PL	5 Gallon Pail — Plastic Tapered Pail	9 ³ / ₄ "	11 ⁵ / ₁₆ "

Screw Style — Standard Unit:

P/N	Description	Pail- Inside Diameter	
		(Minimum)	(Maximum)
344-6	5 Gallon Pail — Straight Side Metal Pail	11 ⁵ / ₁₆ "	
344-6TP	5 Gallon Pail — Metal Tapered Pail	10 ³ / ₄ "	11 ⁵ / ₁₆ "
344-6PL	5 gallon pail — Plastic Tapered Pail	9 ³ / ₄ "	11 ⁵ / ₁₆ "

Note: improved chemical-resistant Viton rubber seals are available; add (-V) to the part number; i.e. 344-7-V



Caulking Loader Adapters:

- Fastens to all Albion Caulking Loaders
- Allows loader to work with different gun styles and to be used to fill cartridges

Gun Styles:

P/N	Description
343-H353	2" Clip Cap Barrel Guns
228-G03	2 ⁵ / ₈ " Diameter Barrel Guns (770 Series Guns)
228-G04	3 ³ / ₈ " Diameter Barrel Guns (103 & 200 Series Guns)

Cartridge Styles:

P/N	Description
343-H351	2 ¹ / ₂ " Diameter — (Quart)
343-H349	2" Diameter
343-H357	1 ⁷ / ₈ " Diameter — 1/10 Gallon and 300ml Two Component
343-H361	1 ⁵ / ₈ " Diameter
228-G06	75ml Two Component
228-G07	150ml Two Component
228-G10	750ml Two Component
343-H445	Piston Stabilizer

GUN ACCESSORIES

BULK LOADING ACCESSORIES— Mixers, Cleaning & Joint Tools

Mixers:

Catalyst Mixer:

- Popular because of its smooth, easy mixing action
- Excellent for color pack or two component urethane applications
- Mixer fits 1/2" drill chuck



P/N	Description	Blade	Shaft Length
381-G01	5 Gallon Pail	6"	18"
381-G02	2 Gallon Pail	4"	18"
381-G03	Stand Up 5 Gallon Pail	6"	28"
381-G04	Stand Up 2 Gallon Pail	4"	28"

Mixing Paddle:

- Fast blending of low viscosity materials; fits 1/4" drill chuck

P/N	Description	Shaft Length
162-G02	One Gallon Pail Mixer	8"
162-G03	5 Gallon Pail Mixer	18"

Prop Mixer:

- Stainless Steel twin propeller mixer for low viscosity materials
- Outer ring shell prevents container punctures; fits 1/4" drill chuck

P/N	Description	Blade	Shaft Length
230-HS	1-2 Gallon Pail Mixer	2 1/2"	15"
230-PS	5 Gallon Pail Mixer	5"	21"

Bulk Barrel Brush:

- Brass bristle brush used to clean inside of 2" diameter STEEL barrels

P/N	Description
800-G01	Curved Handle for Manual Cleaning
800-G02	Straight Shank for Use with Drill
800-H01	Head Replacement

GUN ACCESSORIES

BULK LOADING ACCESSORIES— Mixers, Cleaning & Joint Tools

Joint Tools:



Scraping Tools:

- Rigid stainless steel construction with offset hardwood handle
- Ground knife edge designed to scrape excess material off substrates
- Excellent for saw or flush joints where material overflows the joint
- Excellent for scraping material off container sidewalls

P/N	Blade Measurement
258-33715	2" Wide x 5" Long
258-33719	2 1/2" Wide x 8" Long
258-33718	2" Wide x 8" Long

Caulk Knife:

- Used to remove old caulk and to clean joints
- All steel construction provides additional durability when sliding over rough, stony, or concrete surfaces
- Padded foam grip for comfort
- Holds standard utility blade (blade not included)

P/N	Length	P/N	Length
816-G01	12"	816-G03	24"
816-G02	18"		

Backer Rod Insertion Tools:

- Fully adjustable and places the Backer Rod at any desired depth

P/N	Description
640-5	Standard Model: includes 4 insertion wheels and 1 tamping blade for 1/8", 1/4", 3/8", 1/2" wide joints
640-6	Corner Model: designed for filling joints in a corner; includes 1/8", 1/4", 3/8", 1/2" wide insertion wheels
640-3 (set)	Includes both Standard & Corner Models
640-4	Road Model: similar to 640-5, except handle is reinforced with resin and tamping blade is omitted so attachment port can be used to accept a threaded standard broom handle
640-G20	4 1/2" Wheel Accessory: for 2" Saw Joint



ACCESSORIES

Wheel Accessories:

Joint Widths	Use with 640-3	Use with 640-4 & 5
1/8"	640-G06	640-G02
1/4"	640-G07	640-G03
3/8"	640-G08	640-G04
1/2"	640-G09	640-G05

GUN ACCESSORIES

BULK LOADING ACCESSORIES— Joint Tools & Heat Chest

Joint Tools:



Mini-Joint Tooling Kit: (p/n 556-G01)

- Three hard plastic doubled-ended tools providing the following widths: 1/8", 1/4", 5/16", 3/8", 7/16", 1/2"

Tooling Joints:

- Ensure good adhesion to substrates; Albion joint tools also offer:
- Proper flexibility for perfect finished joints
- Easy solvent clean-up (no plastic components)
- Premium grade stainless steel
- Rounded tips for standard applications
- Easy to modify for unique applications

Classic Spatulas:

- The original hardwood handled classic spatula well known to professionals

P/N	Description	Width
258-3TPS	3" Long Tapered Blade	Tapers from 5/8" to 3/8"
258-3S	3" Long Straight Blade	5/8"
258-4S	4" Long Straight Blade	3/4"
258-5S	5" Long Straight Blade	13/16"
258-6S	6" Long Straight Blade	1"
258-8S	8" Long Straight Blade	1 1/4"
258-10S	10" Long Straight Blade	1 1/2"

Streamline Spatulas:

- Curved steel handle; same blade specifications as 258 Series

P/N	Description	Width
958-G01	Streamline Spatula Set; 7 Piece Bevelled Handle Standard Spatulas	
958-3TPS	3" Long Tapered Blade	Tapers from 5/8" to 3/8"
958-3S	3" Long Straight Blade	5/8"
958-4S	4" Long Straight Blade	3/4"
958-5S	5" Long Straight Blade	13/16"
958-6S	6" Long Straight Blade	1"
958-8S	8" Long Straight Blade	1 1/4"
958-10S	10" Long Straight Blade	1 1/2"

GUN ACCESSORIES

BULK LOADING ACCESSORIES— Joint Tools & Heat Chest

Hot Pot™



Hot Pot™

Change the caulking conditions anytime; sustains sealants, coatings, and adhesives at usable temperatures, even in the coldest conditions (p/n 939-1)

- Heavy gauge steel pail with lid
- 15" high x 18" wide interior
- 120 VAC plug-in
- Ability to hold a case of 10oz cartridges, 20oz sausages, two 2-gallon pails or one 5 gallon pail
- Warms material to optimal temperature in 20 minutes
- Easy maintenance with repair parts
(*heat chest kit (p/n 174-G03) contains all interior parts - no enclosure*)

*Albion would like to credit the contributions made by Philip Porter of the Masonry Preservation Group

Special Tools

Delamination Detection Tool (DDT): (p/n 875-1)

Dramatically increase your speed and accuracy in detecting invisible delamination, voids, and hollows below the surface of concrete compared with tapping with hammers or dragging chains; use for inspecting concrete slabs, parking garages, bridge decks, balconies and tunnels

<u>P/N</u>	<u>Description</u>
875-1	Delamination Detection Tool
876-1	4' - 8' Telescopic Pole for DDT
876-2	6' - 12' Telescopic Pole for DDT

Heavy Duty Contractor Tool Bag: (p/n 968-1)

Keep all your caulking tools together in one place; features include:

- Professional quality
- Heavy duty nylon
- Double handles, zippered top, shoulder strap
- 29 pockets
- 30" x 10" x 10"
- Large enough to comfortably hold several of our largest bulk guns, including cordless guns
- Convenient pockets on inside and outside to keep spare nozzles, caps, spatulas and other accessories within easy reach
- Stay open top makes it easy to add and remove tools

GUN ACCESSORIES

AIR ACCESSORIES— Regulators, Gauges, Kits, Hoses, Plugs & AT-Line

Air Powered

Air Pressure Gauge

137-3



Standard Aluminum Cast T-Pull

240-1



1/8 NPT Regulator

137-5



1/8 NPT Quick Disconnect Plug

363-2



- Air Pressure Gauge (p/n 137-3)
- 1/8 NPT Regulator (p/n 137-5)
- 10" Threaded Air Hose (p/n 272-3-10)
- 1/8 NPT Regulator w/10' Threaded Air Hose (p/n 445-2)
- 1/8 NPT Quick Disconnect Plug (p/n 363-1)
- Standard Aluminum Cast T-Pull (p/n 240-1)

AT-Line Accessories

645-G05

Manifold



957-2

Suitcase Handle Adapter



957-1

Upper Handle



957-3

Standard Handle with Regulator



- Upper Handle (p/n 957-1)
- Suitcase Handle Adapter (p/n 957-2)
- Standard Handle w/Regulator (p/n 957-3)
- 20oz Sausage Gun Manifold, for use with AT1200S and AT1200S-2 (p/n 645-G05)

GUN ACCESSORIES

CORDLESS GUN ACCESSORIES— Batteries, Chargers & Kits

Lithium-ion Battery Pack



Lithium-ion Battery Charger



Cordless Powered

Compact 18v Lithium-ion Battery Pack: (p/n 982-5)

- Standard on Albion cordless guns
- 1.5 amp hour capacity
- Recharge time 30 minutes
- Equivalent run time with 40% less weight than an 18V NiCad battery
- Individual Cell Voltage Monitoring-ensures optimal charge and discharge for maximum life
- Battery Fuel Gauge - Displays remaining run-time

High Capacity 18v Lithium-ion Battery Pack: (p/n 982-5)

- 2.8 amp hour capacity
- Recharge time 60 minutes

Charger for 18v Lithium-ion Batteries: (p/n 982-3)

- Recharges compact battery in 30 minutes
- 110V AC. Euro and Australian versions available.

Lithium-ion Cordless Conversion Kits:

convert any model Albion Lithium-ion gun to any other model

- 995-1 Conversion Kit to 846-1E
- 995-2 Conversion Kit to 405-15E
- 995-3 Conversion Kit to DL-45-T13E
- 995-4 Conversion Kit to DL-59-T13E
- 995-5 Conversion Kit to 770-20E
- 995-6 Conversion Kit to 103-15E
- 995-9 Conversion Kit to DL-45-T20E

Standard Replacement Pull



Pulls

Pulls:

- 145-G15 Standard Li-Io Cordless Pull
- 310-1 Ladder Hook Pull
- 870-2 Cartridge ejector for Cordless

**See page 80 for cordless racks

Notes





Notes





Notes







ALBION Engineering Company

1250 N. Church Street Moorestown, NJ 08057-1102
856-235-6688 Fax Toll-Free: 800-841-7132

www.albioneng.com