

# GUARDIAN

## FALL PROTECTION

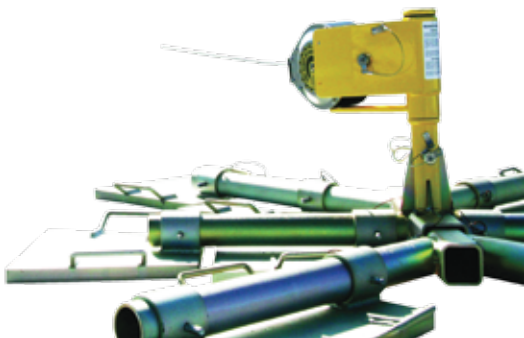

## Product Name: Angel Anchor

Part #: 00260

### Instruction Manual

**Do not throw away these instructions!**

**Read and understand these instructions before using equipment!**

---

Introduction . . . . .	1
Applicable Safety Standards . . . . .	1
Worker Classifications . . . . .	1
Product Specific Applications . . . . .	1 - 2
Limitations . . . . .	2 - 3
Components and Specifications . . . . .	3
Installation and Use . . . . .	4
Maintenance, Cleaning, and Storage . . . . .	5
Inspection . . . . .	5
Inspection Log . . . . .	5
Safety Information . . . . .	6
Labels . . . . .	7

## Introduction

Thank you for purchasing a Guardian Fall Protection Angel Anchor. This manual must be read and understood in its entirety, and used as part of an employee training program as required by OSHA or any applicable state agency.

This and any other included instructions must be made available to the user of the equipment. The user must understand how to safely and effectively use the Angel Anchor, and all fall safety equipment used in combination with the Angel Anchor.

User Information	
Date of First Use:	_____
Serial #:	_____
Trainer:	_____
User:	_____

## Applicable Safety Standards

When used according to instruction specifications, this product meets or exceeds all applicable EN 795-2012 standards for fall protection. Applicable standards and regulations depend on the type of work being done, and also might include state-specific regulations. Consult regulatory agencies for more information on personal fall arrest systems and associated components.

## Worker Classifications



Understand the following definitions of those who work near or who may be exposed to fall hazards.

**Qualified Person:** A person with an accredited degree or certification, and with extensive experience or sufficient professional standing, who is considered proficient in planning and reviewing the conformity of fall protection and rescue systems.

**Competent Person:** A highly trained and experienced person who is ASSIGNED BY THE EMPLOYER to be responsible for all elements of a fall safety program, including, but not limited to, its regulation, management, and application. A person who is proficient in identifying existing and predictable fall hazards, and who has the authority to stop work in order to eliminate hazards.

**Authorized Person:** A person who is assigned by their employer to work around or be subject to potential or existing fall hazards.

**It is the responsibility of a Qualified or Competent person to supervise the job site and ensure all applicable safety regulations are complied with.**

## Product Specific Applications



Use of equipment in unintended applications may result in serious injury or death. Maximum 1 attachment per connection point.



**Personal Fall Arrest:** Angel Anchor may be used to support a MAXIMUM 1 PFAS for use in Fall Arrest applications. Structure must withstand loads applied in the directions permitted by the system of at least 5,000 lbs. Maximum free fall is 6', or up to 12' if used in combination with equipment explicitly certified for such use. Applicable D-ring: Dorsal.



**Restraint:** Angel Anchor may be used in Restraint applications. Restraint systems prevent workers from reaching the leading edge of a fall hazard. Always account for fully deployed length of lanyard/SRL. Structure must withstand loads applied in the directions permitted by the system of at least 1,000 lbs. No free fall is permitted. Restraint systems may only be used on surfaces with slopes up to 4/12 (vertical/horizontal). Applicable D-rings: Dorsal, Chest, Side, Shoulder.

**For all applications: worker weight capacity range (including all clothing, tools, and equipment) is 130-220 lbs.**

## Limitations

**Fall Clearance:** There must be sufficient clearance below the anchorage connector to arrest a fall before the user strikes the ground or an obstruction. When calculating fall clearance, account for a MINIMUM 3' safety factor, deceleration distance, user height, length of lanyard/SRL, harness stretch, anchor deflection, and all other applicable factors.

**Diagram shown is an example fall clearance calculation ONLY.**

**Swing Falls:** Prior to installation or use, make considerations for eliminating or minimizing all swing fall hazards. Swing falls occur when the anchor is not directly above the location where a fall occurs. Always work as close to in line with the anchor point as possible. Swing falls significantly increase the likelihood of serious injury or death in the event of a fall.

**Compatibility:** When making connections with Angel Anchor, eliminate all possibility of roll-out. Roll-out occurs when interference between a hook and the attachment point causes the hook gate to unintentionally open and release. All connections must be selected and deemed compatible with Angel Anchor by a Competent Person. All connector gates must be self-closing and self-locking, and withstand minimum loads of 3,600 lbs. See the following for examples of compatible/incompatible connections:

Fall clearance calculation shown based on standing worker falling directly in-line with anchor point. Always consider potential swing fall and other hazards when calculating fall clearance.

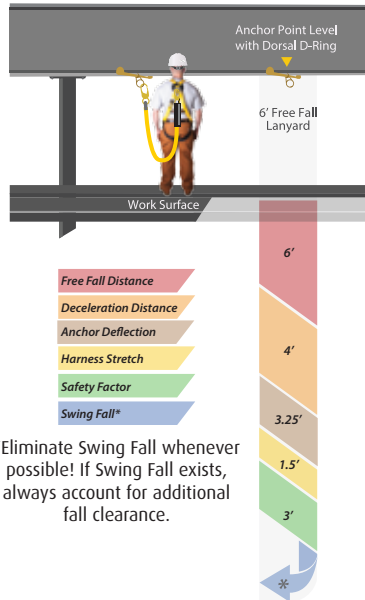

\*Eliminate Swing Fall whenever possible! If Swing Fall exists, always account for additional fall clearance.

Connector closed and locked to D-ring. **OK.**



Two connectors to same D-ring. **NO.**



Connector to integral lanyard. **NO.**



Connector directly to webbing. **NO.**

Incompatible or irregular application, which may increase risk of roll-out. **NO.**



Connector directly to horizontal lifeline. **NO.**

Two or more snap hooks or carabiners connected to each other. **NO.**



**Correct Anchorage Positioning:**

This chart details allowable working zones required to reduce risk of swing falls and improper side loading. **ALWAYS** adhere to information specified by chart.

Anchor Distance From Leading Edge (Y)	Working Distance Along Roof Edge (Either Direction) (X)	Working Angle From Perpendicular (θ)
6'	8'	53°
10'	9' - 9"	45°
15'	11' - 7"	38°
20'	13' - 3"	33°
25'	14' - 6"	30°
30'	16'	28°
35'	17' - 2"	26°
40'	18' - 3"	24°
45'	19' - 4"	23°
50'	19' - 10"	21°
55'	21' - 4"	21°
60'	22' - 3"	21°

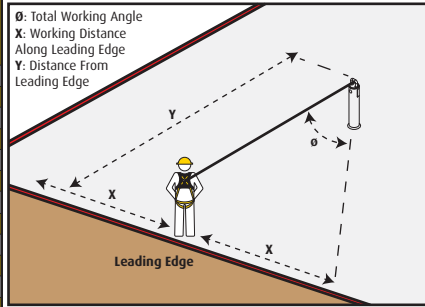

For example, if the anchorage connector is 6' from the leading edge (Y), the working distance (X) is 8' in each direction from the perpendicular, which translates to a 53° working angle.

**Components and Specifications**

Materials: galvanized steel.

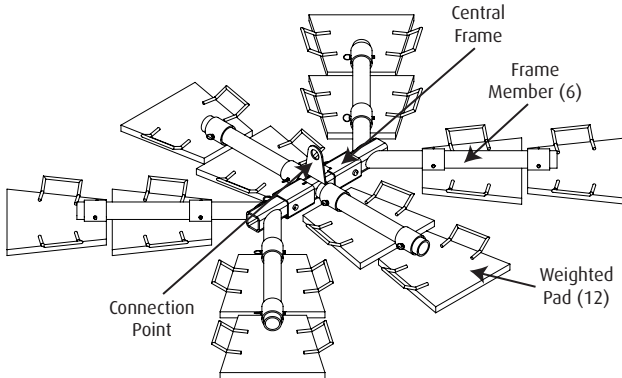

## Installation and Use

### Prior to installation, plan your system:

1. Determine suitable location for anchor; ensure location is free of debris, rot, decay, cracking, and hazardous materials. **Only use Angel Anchor on the following approved substrates:**

- EPDM membrane • Torch down (smooth) • Torch down (granulated) • Cement • Wood • TPO • Vinyl • PVC

**Ensure Angel Anchor Weighted Pads have wear-resistant natural gum foam rubber padding affixed prior to use.**

2. Eliminate/minimize all risks of swing fall.
3. Compatible for use on surfaces with pitches up to 1/12 (5°).
4. ALWAYS place anchor on roof pitch opposite work surface, and a MINIMUM 10' from both the ridge and all leading edges.

**Wind load rating: 85 MPH.**

**DO NOT USE if potential exists for exposure to wind gusts greater than 85 MPH.**

### Installation:

1. Select the intended position of the Angel Anchor, ensuring that no part of the anchor is less than 10' from any edge, roof opening, or leading edge. Installation location MUST be free for all loose materials, debris, and hazardous materials.

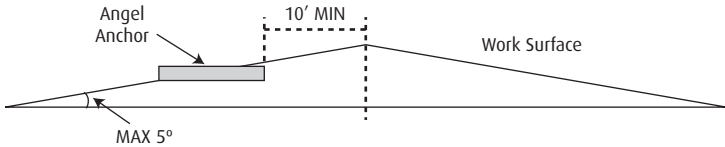

2. Place Central Frame at selected installation location, and arrange (12) Weighted Pads around frame.

3. With the anti-skid/rubber padding side down, slide one Weighted Pad onto each frame member, 3/4 down the tube.

4. Slide a second Weighted Pad onto each frame member, anti-skid side down. Pad collar must be completely on frame member.

5. Align holes on frame with Weighted Pad collar holes, then insert locking bars and secure with pins.

6. Inspect to ensure all Weighted Pads are fully secured to frame.

7. Connect complete and compatible PFAS to provided anchor point.

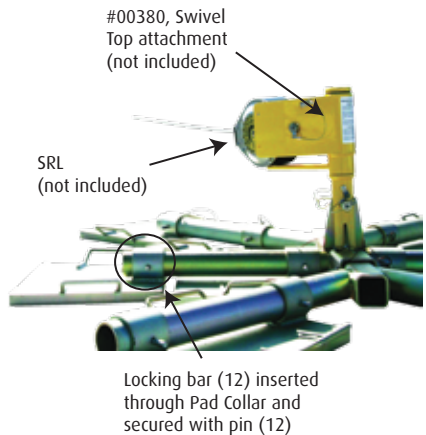

**\*Angel Anchor may be used in combination with a compatible horizontal lifeline (HLL) system for use in Restraint applications ONLY. Maximum 2 workers per Angel Anchor HLL system.**

## Maintenance, Cleaning, and Storage

If Angel Anchor fails inspection in any way, immediately remove it from service, and contact Guardian to inquire about its return or repair.

Cleaning after use is important for maintaining the safety and longevity of Angel Anchor. Remove all dirt, corrosives, and contaminants from Angel Anchor before and after each use. If Angel Anchor cannot be cleaned with plain water, use mild soap and water, then rinse and wipe dry. NEVER clean Angel Anchor with corrosive substances.

When not in use, store equipment where it will not be affected by heat, light, excessive moisture, chemicals, or other degrading elements.

## Inspection

Prior to EACH use, inspect Angel Anchor for deficiencies, including, but not limited to, corrosion, deformation, pits, burrs, rough surfaces, sharp edges, cracking, rust, paint buildup, excessive heating, alteration, and missing or illegible labels. IMMEDIATELY remove Angel Anchor from service if defects or damage are found, or if exposed to forces of fall arrest.

Angel Anchor functionality dependent on friction; DO NOT USE if anti-skid/rubber padding side of any Weighted Pad indicates any sign of wear.

Ensure that applicable work area is free of all damage, including, but not limited to, debris, rot, rust, decay, cracking, and hazardous materials. Ensure that selected work area will support the application-specific minimum loads set forth in this instruction manual. Work area MUST be stable.

At least every 6 months, a Competent Person other than the user must inspect Angel Anchor. **Competent Person inspections MUST be recorded in inspection log in instruction manual and on equipment inspection grid label. The Competent Person must sign their initials in the box corresponding to the month and year the inspection took place.**

During inspection, consider all applications and hazards Angel Anchor have been subjected to.

## Inspection Log

Date of First Use: \_\_\_\_\_.

**Product lifetime is indefinite as long as it passes pre-use and Competent Person inspections. User must inspect prior to EACH use. Competent Person other than user must complete formal inspection at least every 6 months. Competent Person to inspect and initial.**

**This inspection log must be specific to one Angel Anchor. Separate inspection logs must be used for each Angel Anchor. All inspection records must be made visible and available to all users at all times.**

	J	F	M	A	M	J	J	A	S	O	N	D
YR												
YR												
YR												
YR												
YR												

**If equipment fails inspection IMMEDIATELY REMOVE FROM SERVICE.**

## Safety Information



Failure to understand and comply with safety regulations may result in serious injury or death. Regulations included herein are not all-inclusive, are for reference only, and are not intended to replace a Competent Person's judgment or knowledge of federal or state standards.

Do not alter equipment. Do not misuse equipment.

Workplace conditions, including, but not limited to, flame, corrosive chemicals, electrical shock, sharp objects, machinery, abrasive substances, weather conditions, and uneven surfaces, must be assessed by a Competent Person before fall protection equipment is selected.

The analysis of the workplace must anticipate where workers will be performing their duties, the routes they will take to reach their work, and the potential and existing fall hazards they may be exposed to. Fall protection equipment must be chosen by a Competent Person. Selections must account for all potential hazardous workplace conditions. All fall protection equipment should be purchased new and in an unused condition.

Fall protection systems must be selected and installed under the supervision of a Competent Person, and used in a compliant manner. Fall protection systems must be designed in a manner compliant with all federal, state, and safety regulations. Forces applied to anchors must be calculated by a Competent Person.

Unless explicitly stated otherwise, the maximum allowable free fall distance for lanyards must not exceed 6'. No free fall allowed for non-LE SRLs. Class A SRLs must arrest falls within 24"; Class B SRLs must arrest falls within 54".

Harnesses and connectors selected must be compliant with manufacturer's instructions, and must be of compatible size and configuration. Snap hooks, carabiners, and other connectors must be selected and applied in a compatible fashion. All risk of disengagement must be eliminated. All snap hooks and carabiners must be self-locking and self-closing, and must never be connected to each other.

A pre-planned rescue procedure in the case of a fall is required. The rescue plan must be project-specific. The rescue plan must allow for employees to rescue themselves, or provide an alternative means for their prompt rescue. Store rescue equipment in an easily accessible and clearly marked area.

Training of Authorized Persons to correctly erect, disassemble, inspect, maintain, store, and use equipment must be provided by a Competent Person. Training must include the ability to recognize fall hazards, minimize the likelihood of fall hazards, and the correct use of personal fall arrest systems.



NEVER use fall protection equipment of any kind to hang, lift, support, or hoist tools or equipment, unless explicitly certified for such use.

Equipment subjected to forces of fall arrest must immediately be removed from use.

Age, fitness, and health conditions can seriously affect the worker should a fall occur. Consult a doctor if there is any reason to doubt a user's ability to withstand and safely absorb fall arrest forces or perform set-up of equipment. Pregnant women and minors must not use this equipment.

Physical harm may still occur even if fall safety equipment functions correctly. Sustained post-fall suspension may result in serious injury or death. Use trauma relief straps to reduce the effects of suspension trauma.

## Labels

	<b>Angel Anchor</b> Part # 00260	www.guardianfall.com 1-800-466-6385
	<p><b>Prior to use, read and understand all manufacturer's instructions provided with equipment at time of shipment.</b></p> Compliant with all EN 795-2012 regulations. Capacity range: 130-220 lbs. Materials: galvanized steel. Type E. All connections must be selected and deemed compatible with the Angel Anchor by a Competent Person.	Date of Manufacture: <div style="background-color: black; width: 100px; height: 15px;"></div> 90175 (Rev. F) Made in China
 <b>WARNING</b>	Avoid contact with all hazards, including electrical shock, corrosive chemicals, and sharp/abrasive edges and surfaces. For use by one worker only. <b>ONLY use on compatible substrate. See instructions.</b>	

<p><b>INSPECTION GRID</b></p> User must inspect prior to EACH use. Competent Person must complete formal inspection every 6 months. Competent Person to inspect and initial. Date of First Use: _____ <b>Product lifetime is indefinite as long as equipment passes pre-use and Competent Person inspections.</b> If equipment fails inspection IMMEDIATELY REMOVE FROM SERVICE.													<b>DO NOT REMOVE LABELS</b>
YR	J	F	M	A	M	J	J	A	S	O	N	D	
MO													
20__													
20__													
20__													
20__													